

Creating ergonomic spaces  
that offer the  
**comfort of home,  
at the office.**



”” The boundaries between our personal and work life are disappearing. Workspaces are becoming second homes and from this arises the need to have home-like comfort in the office.

At Godrej Interio, we create workspaces that are flexible, smart and intuitive. This not only ensures good health but also results in a stress-free environment and improved productivity.

So, be it seating, desking, storage or modular workstations, when it comes to enhancing productivity in workplace dynamics, our range always lets you

**Make Space for Life.** ””

## About us:

Godrej Interio (GI) is India's premium furniture brand in both home and institutional segments with a strong commitment to sustainability and centers of excellence in design, manufacturing and retail.

Led by the largest in-house design team in the country in the furniture category and awarded with 34 India Design Mark Awards till date, GI aims to transform spaces with its thoughtfully designed furniture to create brighter homes and offices with products that have the highest design quotient in aesthetics, functionality and technology. With consistent pursuit of excellence and a special focus on health and ergonomics, GI's product portfolio comprises a massive range.

Today, we design and manufacture furniture for office spaces, homes, educational institutes, healthcare facilities, laboratories and more. Along with furniture we offer Audio Visual and 360 Degree Turnkey solutions. Each of our product range revolves around comfort and aesthetics while delivering well-designed, fun and functional furniture solutions. Briefly, Godrej Interio transforms dream spaces to life!



Godrej Interio has 8 manufacturing facilities situated at Mumbai, Khalapur, Haridwar, Shirwal, and Bhagwanpur. GI's Shirwal Plant is Green Co Platinum Certified and Mumbai Plants are Green Co Gold Certified. GI is widely known for its comprehensive sustainability certifications for its products in furniture category.

GI's commitment to the environment has resulted in manufacturing products with lesser environment footprint. Our pioneering efforts include designing less environment burdening products, usage of eco-friendly materials and setting up less polluting and consuming processes, ensuring eco-friendly packaging, and transportation and finally the extended responsibility of recycling/reuse of used furniture and scrap, thus ensuring a lifecycle approach to green. GI has the widest range of green choices for our customers which not only includes products but also services such as green interiors and recycling.

Currently present in over 650 cities with 300+ exclusive showrooms and 1200+ dealers, GI is one of the largest divisions of Godrej and Boyce Mfg. Co. Ltd., part of the Godrej Group, one of India's largest engineering and customer product groups.



# Our Presence



 Our Branches

 Our Factory

## Awards & Recognitions



Godrej Interio received  
**"CII-Exim Bank Award"**  
 for Business Excellence in 2017



Godrej Interio Vikhroli Plants received  
**"Energy Efficient Unit Award"**  
 at the 17th CII National Energy Summit.



Godrej Interio Shirwal Plant received  
**"Excellent Energy Efficient Unit Award"**  
 at the 17th CII National Energy Summit.



Godrej Interio received  
**"Greenco Best Practices Award"**  
 at the 17th CII National Energy Summit.



Godrej Interio received  
**"Super Brand"** award at the Super  
 Brands event held in Delhi.

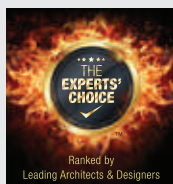

Godrej Interio was awarded  
 top rank in the furniture category,  
**"Experts' Choice Award 2018"**



**World's Greatest Brands & Leaders**  
 2016-17 – Asia & GCC

# We don't just talk green. We walk green.

At Godrej Interio, our sustainability goals are ambitious. We do not just talk, we walk the talk.

We take our work seriously because we know our products and services touch people, transform lives and change the world.

When we add the element of sustainability and green living into what we do, it adds the positivity of hope to the promise of a better future, not only for people but for the planet as a whole.

We are transparent about our green goals.

Every day, in every way, we achieve and surpass these goals in our endeavor to give shape to our vision of an ideal, sustainable world.

## Our good and green vision

### Creating a Greener India

By 2020, we will achieve 45% reduction in specific energy consumption, 50% reduction in specific water consumption, 15% renewable energy use, zero waste to landfill and positive water balance.

### Innovating for Good and Green Products

By 2020, we will have a third of our portfolio revenues comprising of Good and Green Products and Services.

### Ensuring Employability

Train 15000 rural and urban youth in skilled employment by 2020.

## We ensure sustainability across the value chain



### Materials

- Design for Environment
- Green Materials
- LCA



### Transportation

- Green Modes of transportation



### Manufacturing

- Energy Efficiency
- Zero waste water discharge
- Renewal Energy
- Zero waste landfill



### In use

- Low emitting Products
- Green Certification
- AMC



### Packaging

- Flat packaging
- Right packaging



### End of life

- Recycling program
- Safe disposal

Greenco  
certifications  
awarded to  
Vikhroli and  
Shirwal Units



 **Talk Green.  
Walk Green.**





# CONTENTS

## DESKING

### PREMIUM SUITS

COEVAL	18
ARISTO	19
TOPAZ	20
CIGNUS	21
ARRIVE	22
IMPRESS	23
MAESTRO	24

### EXECUTIVE SUITS

ARISTO	26
TOPAZ	27
CIGNUS	28
TRIDENT SENIOR	29
TRIDENT MIDDLE	30
MAYFAIR	31
ASCENT	32
FINESSE	33

### OFFICE DESKS

ENTERPRISE	36
ARISTO	37
TOPAZ	38
CIGNUS	39
ENZO	40

## **DESKING**

### **CONFERENCE TABLE**

MINGLE – MODULAR	42
MINGLE – ELEGANCE AV	44
MINGLE – UNITIZED	46
MINGLE – GATHER	48
MINGLE – VC COLAB	49
MINGLE – POD	50
CONCLAVE	51

### **TRAINING TABLES**

UNLEARN	54
FLIP NXT	55

### **CAFETERIA AND BREAKOUT AREAS**

CAFE POD	58
TIME OUT	59
FLIP NXT	60

## SEATING

### LEATHER AND LETHERETTE

LA SEDE	62
MARVEL	63
VERSA NEO	64
SEDNA	65
BEAT	66
KAREENA NXT	67
ELITE	68

### MESH BACK CHAIRS

GRETA	70
ACE	71
VERSA MESH	72
PULSE	73
OXBO	74
AERO	75
CROSS	76

### CUSHION BACK CHAIRS

MOTION	78
VERSA CANVAS	79
VERSA CUSHION	80
BRAVO	81

### TRAINING ROOM CHAIRS

SCINITILLA DESKLET	84
UNWIND WITH DESKLET	85

## SEATING

### MULTIPURPOSE

UNWIND WITH ARMREST	88
SCINTILLA WITH AND WITHOUT ARMREST	89

### CAFETERIA & BREAKOUT CHAIRS

UNWIND WITHOUT ARMREST	92
SCINTILLA HIGH CHAIR	93
UNWIND HIGH SEATING	94

### BREAKOUT & COLLABORATIVE SEATING

EEZYSIT	96
---------	----

### PUBLIC SEATING

MATRIX	98
--------	----

### LOUNGE SEATING

MIDAS	100
PISA	101

### AUDITORIUM SEATING

MARS	104
ECO MARS	105
GLAMOUR NXT	106
VENUS	107
JUPITER	108

## SEATING

### INTERACTIVE ACTIVE SEATING

#### ACTIVE SEATING SOLUTION

LOOP	110
CRADLE	111
DRIFT	112
TOGGLE	113
PROP TABLE	114

### CUE

CUE WORK LOUNGE	116
-----------------	-----

## OPOS

#### MOBILE SYSTEMS

HABITAT	120
---------	-----

#### TILE BASED SYSTEMS

WISH	124
XPRESS OFFICE	124
WALL FULL HEIGHT PARTITIONS	125

#### DESK BASED SYSTEM

DFINE	128
REASON	128
UPBEAT	129

## STORAGE

### AISLE & BACK STORAGE

MOBILE CADDY	132
CELL PHONE LOCKERS	133
RESERVE	134
ECHO	135
TAMBOUR DOOR UNIT	136
CUSHION LFC AND PEDESTAL	137
VERTICAL FILING CABINET	138
LATERAL FILING CABINET	139
SLIDING DOOR UNIT	140
STORE UP	141

### DISPLAY STORAGE

PERIODICAL DISPLAY RACK (PDR)	144
SLIDING GLASS DOOR UNIT	145

### PERSONAL STORAGE

NOVA	148
WOODEN PLU	149
PERSONAL LOCKER UNIT	150

### CONVENTIONAL STORAGE

KD PLAIN	152
KD MINOR	153

### HIGH DENSITY STORAGE

TILE OPTIMIZER	156
METAL OPTIMIZER	157
METAL OPTIMIZER	158

## SOCIAL OFFICE

IMMERSE WORK POD	160
ASSERT TABLE	160
ASSERT BENCH	161
VIVID CHAIR	161
OMEGA PLANTER	162
OMEGA BENCH	162
TOPO SQUARE	163
TOPO CIRCLE	163
TOPO HI BITE	164
TOPO FACET	164
TOPO RECTA	165
MODESK	165
TETRIS-FIXED VERSION	166
GRAPH BACK 2 BACK SOFA	166
GREET CHAIR	167
ORBB	167
GRAPH SOFA	168
TETRIS-FLIP VERSION	168
GRAPH BENCH	169
RADIX HI – STOOL	169
ORBB POUFEE	170
CLARITY LAMP	170
TETRA SINGLE TRIANGULAR LAMP	171
NOTEBOOK SCREEN	171
NEO BOOK SHELF	172

## COLOUR SWATCH

CREPE FABRIC SEATING (FC) – VOILA	174
KNITTED FABRIC SEATING (FK)	174
FOAM LAMINATED FABRIC SEATING (FL)	174
BREAKOUT & SOFA FABRIC SEATING (FB), (FS)	174
PLUSH FABRIC (FP)	175
LEATHER & LEATHERETTE SEATING (LT, LC & LS)	175
NET/ MICRO/ SPACER MESH FABRIC SEATING (NM & SF)	175
ZIP & PULLERS SEATING	176
THREAD COLORS SEATING (TP & TN)	176
PLASTICS (PL)	177
UNWIND RANGE	177





# DESKING

PREMIUM SUITS

DESKING/Premium Suites/**Coeval**



**Features:**

- High gloss PU finished panels with toughened streak glass modesty for main desk
- Multiple options in return units for varied user preferences
- Push-to-open mechanism for all drawers
- Multiple storage options provided in the form of return units, back units, storage units and pedestal
- In built lights feature to adjust as per feel and requirement

**Line Diagram**

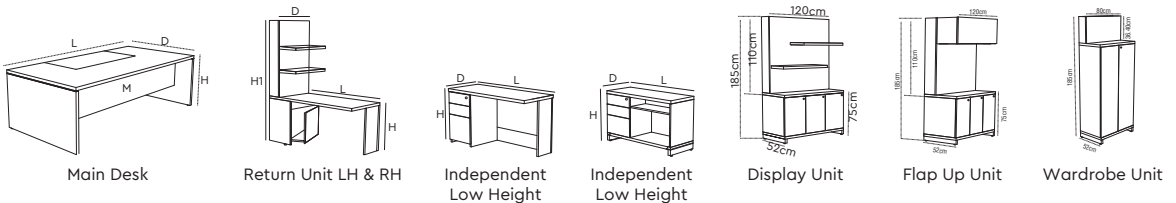

**Specification**

*All sizes in CM*

Model	Length	Depth	Height
Main Desk option 1	240	105	75
Main Desk option 2	210	90	75
Return Unit 700D	202	70	185
Return Unit 550D	150	55	75
Independent Low Height	120	52	75
Return Unit			
Display Unit	120	52	185
Flap Up Unit	120	52	185
Wardrobe unit	80	52	185
Medium Height Back Unit	120	52	120
Table Height Back Unit	120	52	75
Pedestal	40	58.50	54.70

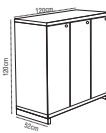

Medium Height Back Unit



Table Height Back Unit

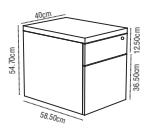

Pedestal

**Colour Swatch**



White PU



**Features:**

- Softened corners ensure comfort and convenience
- Chamfered edge offers user comfort while working
- A simple horizontal line pattern and dark wood grains redefine elegance
- The soft close sliding doors, with aluminium handles for back units ensure ease of operation

**Line Diagram**

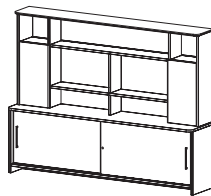
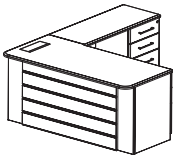

Back Unit 1

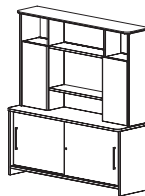

Back Unit 2

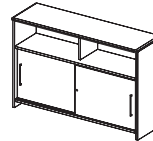

Back Unit 3

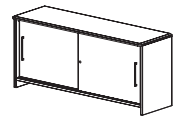

Back Unit 4

**Specification**

*All sizes in CM*

Model	Length	Depth	Height
Main Table +	165	195	75
Eru With Pedestal	180	210	75
	210	225	75
	235	235	75
Main Table + Eru (W/o Eru Pedestal)	165	165	75
Back Unit 1	235	50	180
Back Unit 2	165	50	180
	180	50	180
Back Unit 3	165	50	115
	180	50	115
	235	50	115
Back Unit 4	165	50	75
	180	50	75
	235	50	75

**Colour Switch**



MB112 -  
Tobacco Ash  
+ LM01  
Black Ink

DESKING/Premium Suites/**Topaz**



**Features:**

- Clean lines and surfaces enhance the overall look, blending well with raw wood grain and aesthetic door handles
- Simple geometric lines throughout the panel with optimum use of lighter shades, highlight neatness
- A unique pattern on the fascia and modesty panel ups the style quotient

**Line Diagram**

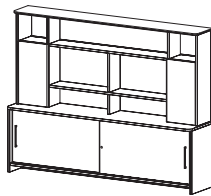
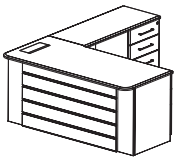

Back Unit 1

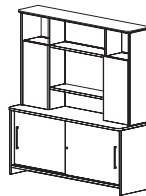

Back Unit 2

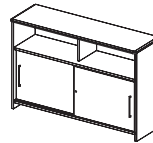

Back Unit 3

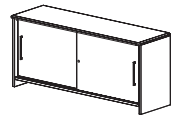

Back Unit 4

**Specification**

*All sizes in CM*

Model	Length	Depth	Height
Main Table +	165	195	75
Eru With Pedestal	180	210	75
	210	225	75
	235	235	75
Main Table + Eru (W/o Eru Pedestal)	165	165	75
Back Unit 1	235	50	180
Back Unit 2	165	50	180
	180	50	180
Back Unit 3	165	50	115
	180	50	115
	235	50	115
Back Unit 4	165	50	75
	180	50	75
	235	50	75

**Colour Swatch**



MB113 -  
Tiepolo PC  
+ LM27 -  
Frosty White



LM97 -  
Rimini Walnut  
+ LM27 -  
Frosty White



**Features:**

- Inspired by the grace of Swan the flowing design of return unit blends seamlessly into the main table. The contrasting colors aesthetically highlight the same
- The flowing lines continue on the modesty with a slanted cut to the panel that perfectly complements the return unit

**Line Diagram**

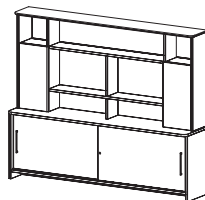
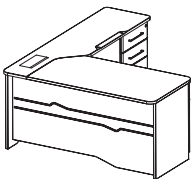

Back Unit 1

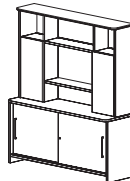

Back Unit 2

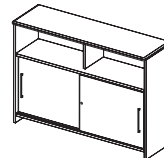

Back Unit 3

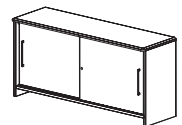

Back Unit 4

**Specification**

All sizes in CM

Model	Length	Depth	Height
Main Table +	165	195	75
Eru With Pedestal	180	210	75
	210	225	75
	235	235	75
Main Table + Eru	165	165	75
(W/o Eru Pedestal)			
Back Unit 1	235	50	180
Back Unit 2	165	50	180
	180	50	180
Back Unit 3	165	50	115
	180	50	115
	235	50	115
Back Unit 4	165	50	75
	180	50	75
	235	50	75

**Colour Swatch**



LM100 -  
Noce  
Versailles  
+ LM27 -  
Frosty  
White



MB115 -  
Nova  
Magnolia  
+  
LM100 -  
Noce  
Versailles

DESKING/Premium Suites/ **Arrive**



**Features:**

- An all Veneer Desk, it shows off status and luxury
- The softness of the Italian black leather is combined with the rigidity of square table-board, tempering force with grace
- The sleek design with smart case-space slides effortlessly in style
- Perfect for storing all your files and papers. Keeps your desk clutter-free

**Line Diagram**

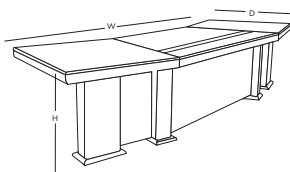

Main Desk

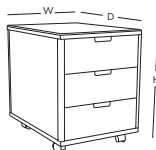

Pedestal

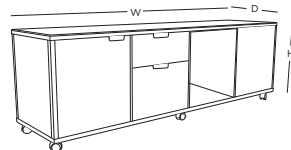

Mobile Cabinet

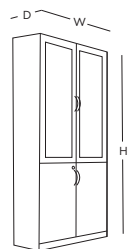

Back Unit

**Specification**

*All sizes in CM*

Model	Length	Depth	Height
Main Desk	360	108	75
Mobile Cabinet	190.70	48	55
Pedestal	48	64	54.60
Back Unit	100	48	204

**Colour Swatch**



Walnut Veneer

DESKING/Premium Suites/ **Impress**



**Features:**

- Veneer finish for premium aesthetic
- Leather pad ensures comfort while working and reduces wear and tear of the work top
- Provision for wire management ensures a clutter-free desk
- Side Unit can be placed on either side of the user and has ample storage space

**Line Diagram**

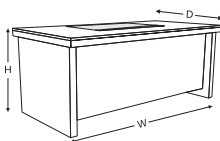

Executive Desk

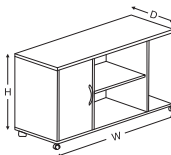

Mobile Side Unit

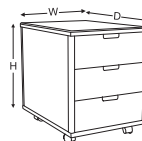

Mobile Pedestal

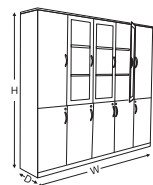

Credenza

**Specification**

*All sizes in CM*

Model	Length	Depth	Height
Impress Executive Desk	180/240	90	75
Impress Mobile Side Unit	120	44	65
Impress Mobile Pedestal	44.30	51	63.50
Impress Credenza	221.10	41	200

**Colour Swatch**



Oxford Cherry & Black

DESKING/Premium Suites/ **Maestro**



**Features:**

- **DUCK NOSE PROFILE EDGE:** It enhances the workplace aesthetics
- **SIDE UNIT WITH PEDESTAL:** The extended table provides extra storage space
- **JOINERY TABLE:** The joinery table can be used for impromptu meetings
- **HANDLES:** The pedestal stand with its stylish handles adds to the aesthetic sense

**Line Diagram**

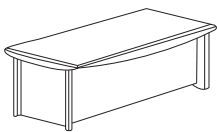

Executive Desk



Side Unit



Mobile Pedestal



Credenza

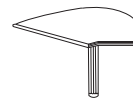

Joining Top

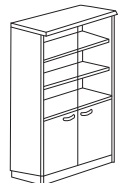

Bookcase Unit

**Specification**

*All sizes in CM*

Model	Length	Depth	Height
Executive Desk	180	90	75
Credenza	140	47	76
Side Unit	120	60	73
Joining Top	105	120	75
Mobile Pedestal	40	56	56
Bookcase Unit	79	40	220

**Colour Swatch**



Oxford Cherry  
with Black  
Joining top





# DESKING

EXECUTIVE SUITS

DESKING/Executive Series/ **Aristo**



**Features:**

- Softened corners ensure comfort and convenience
- Chamfered edge offers user comfort while working
- A simple horizontal line pattern and dark wood grains redefine elegance
- The soft close sliding doors, with aluminium handles for back units ensure ease of operation

**Line Diagram**

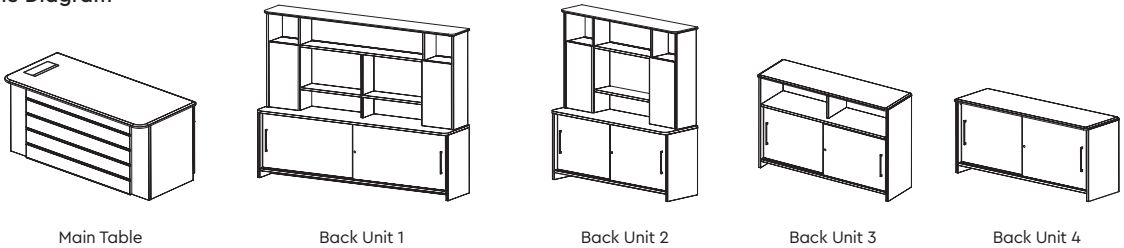

**Specification**

*All sizes in CM*

Model	Length	Depth	Height
Main Table	165	195	75
	180	210	75
Back Unit 1	235	50	180
Back Unit 2	165	50	180
	180	50	180
Back Unit 3	165	50	115
	180	50	115
	235	50	115
Back Unit 4	165	50	75
	180	50	75
	235	50	75

**Colour Swatch**



*MB112 -  
Tobacco Ash  
+ LM01  
Black Ink*

*Design Registered*

DESKING/Executive Series/ **Topaz**



**Features:**

- Clean lines and surfaces enhance the overall look, blending well with raw wood grain and aesthetic door handles
- Simple geometric lines throughout the panel with optimum use of lighter shades, highlight neatness
- A unique pattern on the fascia and modesty panel ups the style quotient

**Line Diagram**

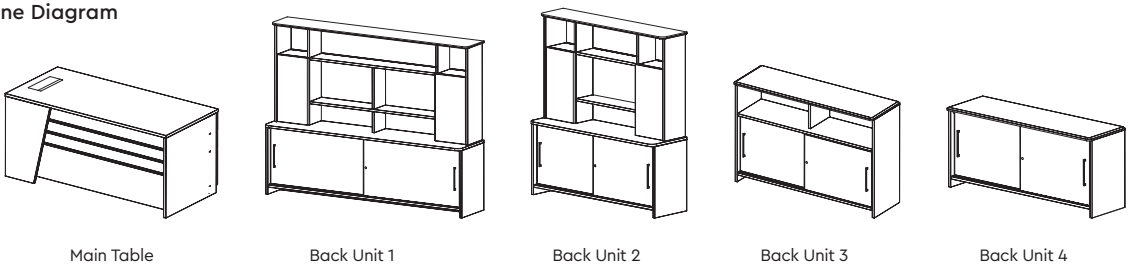

**Specification**

All sizes in CM

Model	Length	Depth	Height
Main Table	165	75	75
	180	90	75
Back Unit 1	235	50	180
Back Unit 2	165	50	180
	180	50	180
Back Unit 3	165	50	115
	180	50	115
	235	50	115
Back Unit 4	165	50	75
	180	50	75
	235	50	75

**Colour Swatch**



MB113 - Tiepolo PC  
+ LM27 - Frosty White



LM97 - Rimini Walnut  
+ LM27 - Frosty White

DESKING/Executive Series/ **Cignus**

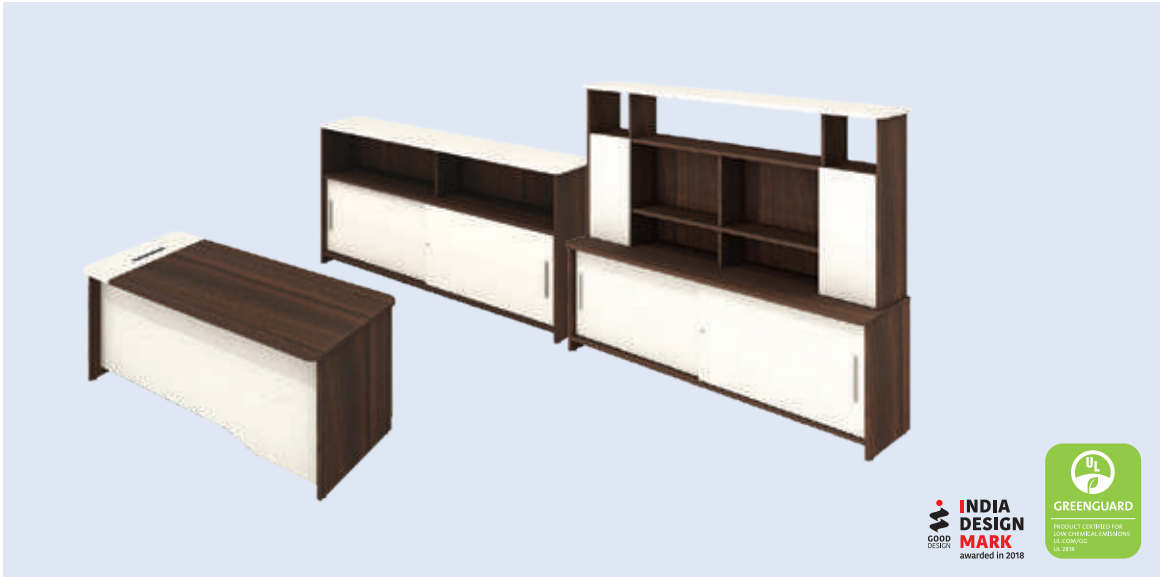

**Features:**

- Inspired by the grace of Swan, the flowing design of return unit blends seamlessly into the main table. The contrasting colors aesthetically highlight the same
- The flowing lines continue on the modesty with a slanted cut to the panel that perfectly complements the return unit

**Line Diagram**

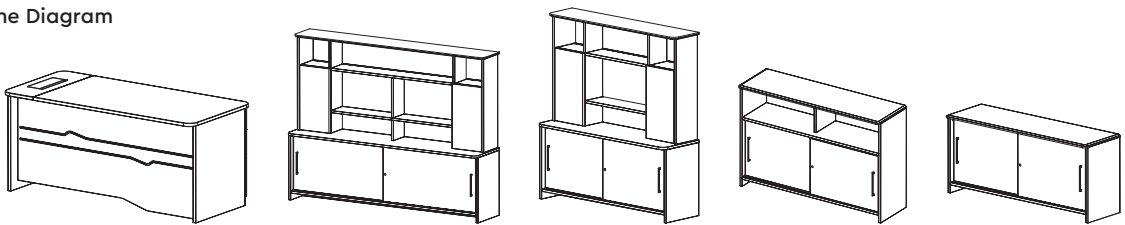

Main Table

Back Unit 1

Back Unit 2

Back Unit 3

Back Unit 4

**Specification**

All sizes in CM

Model	Length	Depth	Height
Main Table	165	75	75
	180	90	75
Back Unit 1	235	50	180
Back Unit 2	165	50	180
	180	50	180
Back Unit 3	165	50	115
	180	50	115
	235	50	115
Back Unit 4	165	50	75
	180	50	75
	235	50	75

**Colour Switch**



LM100 -  
Noce Versailles  
+ LM27 -  
Frosty White



MB115-  
Nova Magnolia  
+ LM100 -  
Noce Versailles

Design Registered

DESKING/Executive Series/ **Trident Senior**



**Features:**

- Floating top with rounded edges
- It comprises of an Executive Desk and Credenza with open shelf space
- The Desk Top and Credenza Top are made of Medium Density Fibre board (MDF) with membrane foil for scratch and stain resistant work surface

**Line Diagram**

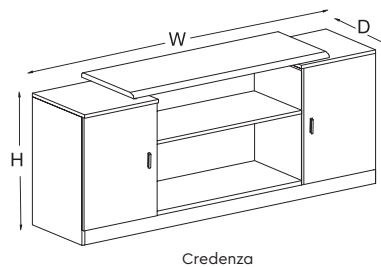
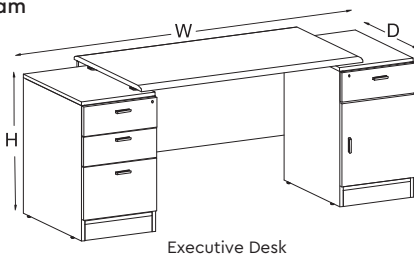

**Specification**

*All sizes in CM*

Model	Length	Depth	Height
Executive Desk	180.40	75	75
Credenza	180.40	45	75

**Colour Swatch**



LM93  
Palau Teak

MB115-  
Nova Magnolia

LM104  
Kitami Elm

DESKING/Executive Series/ **Trident Middle**



**Features:**

- Compact design comprising of an Executive Desk and a Side Unit
- Has an in-built shelf below the work surface for storing documents
- The Side Unit has an in-built keyboard pull-out tray
- Option of LHS and RHS configuration to suit any cabin layout

**Line Diagram**

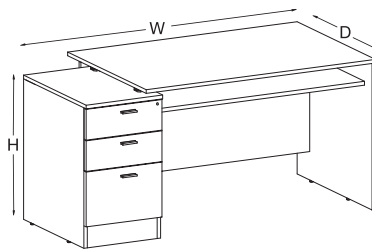

Executive Desk

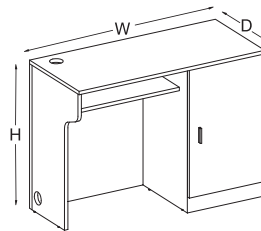

Side Unit

**Specification**

*All sizes in CM*

Model	Length	Depth	Height
Executive Desk	165	70	74.30
Side Unit	100	45	74.30

**Colour Switch**



LM93  
Palau Teak  
+ LM27  
Frosty White

DESKING/Executive Series/ **Mayfair**



**Features:**

- Its unique mix of White Cedar and Black enlivens the ambience in your cabin
- Completes the cabin with Executive Desk, Pedestal, Side Unit and Credenza
- Neat look with grommet for wires on Executive Desk & Side Unit
- Fits into different cabin layouts due to variety of sizes

**Line Diagram**

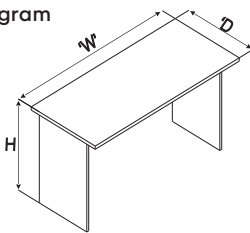

Executive Desk

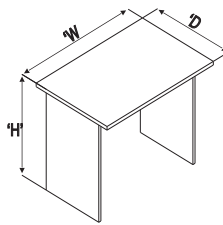

Side Unit

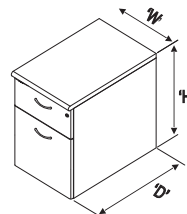

Mobile Pedestal

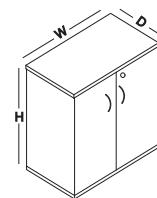

Credenza

**Specification**

All sizes in CM

Model	Length	Depth	Height
Executive Desk	90	60	75
	120	60	75
	135	75	75
Side Unit	90	45	75
	120	45	75
Mobile Pedestal	39	43.50	52.90
Credenza	75	42.50	75

**Colour Swatch**



LM91  
Malaga Cherry  
+ LM09  
Cloud Grey

DESKING/Executive Series/ **Ascent**



**Features:**

- Raised-leg design and floating top
- Utility tray and space for CPU for an organized workspace

**Line Diagram**

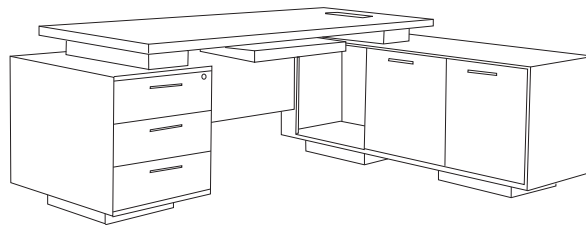

**Specification**

*All sizes in CM*

Model	Length	Depth	Height
Overall	210	72.70	76.50
Executive Desk	180	79.50	76.50
Side Unit	160	50	65

**Colour Swatch**



*Maple*





**Features:**

- Executive Desk and Side Unit available in different sizes to suit varying cabin sizes
- Cut-outs on Executive Desk Top for wire management
- Option of LHS/RHS configurations to suit any cabin layout

**Line Diagram**

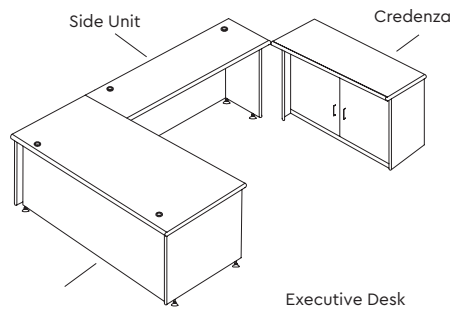

**Specification**

*All sizes in CM*

Model	Length	Depth	Height
Finesse Executive Desk 4020	120	60	74
Finesse Executive Desk 5026	150	75	74
Finesse Executive Desk 5630	165	90	74
Finesse Executive Desk 6030	180	90	74
Finesse Side Unit 3619	105	45	70.50
Finesse Side Unit 5219	155	45	70.50
Finesse Credenza 4319	128	42.50	70.50

**Colour Swatch**



LM103 -  
Bavarian  
Beech  
+ LM01 -  
Black Ink



LM09 -  
Cloud Grey



# DESKING

OFFICE DESKS

DESKING/Office Desks/ **Enterprise**



**Features:**

- **WIRE SLOTS:** Slots provided in the top frame for passage of wires
- **WOODEN MODESTY:** Wooden Modesty panel offers the needed privacy, available in 1500 and 1650 width tables only
- **WIRE CARRIER:** Vertical and Horizontal Wire Carrier ensures a clutter-free and organized desk
- **CPU MOUNT:** An Accessory: CPU Mount ensures that the CPU does not take space on the floor
- **STORAGE SPACE:** Sufficient storage provided in the pedestal takes care of the storage requirement

**Line Diagram**

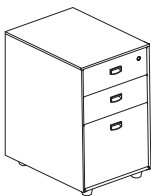

Enterprise Pedestal

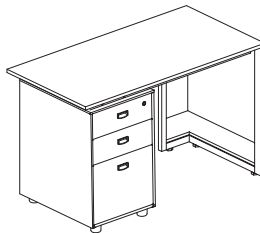

LH Table

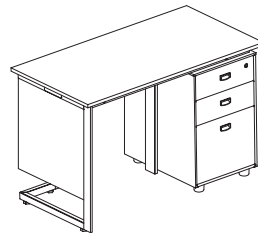

RH Table

**Specification**

All sizes in CM

Model	Length	Depth	Height
Executive Desk	120	60	72.80
	135	75	72.80
	150	75	72.80
	165	90	72.80

**Colour Swatch**



LM94 - Siam Teak + PW81 - Sepia Brown



LM93 - Palau Teak + PW27 - Tex. Bond White



LM100 - Noce Versailles + PW15 - Gargoyle



**Features:**

- Softened corners ensure comfort and convenience
- Chamfered edge offers user comfort while working
- A simple horizontal line pattern and dark wood grains redefine elegance
- The soft close sliding doors, with aluminium handles for back units ensure ease of operation

**Line Diagram**

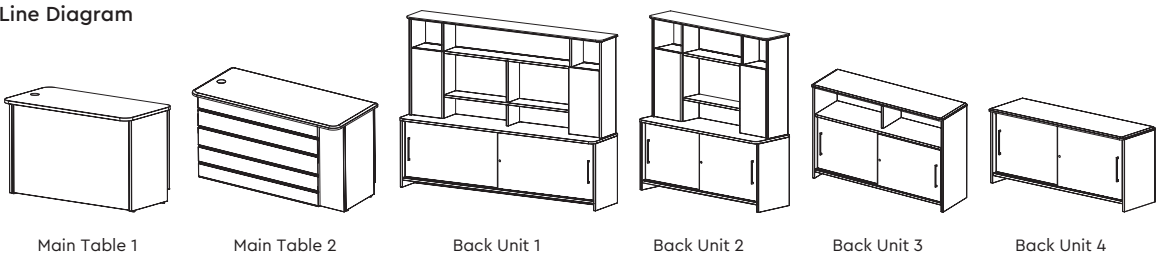

**Specification**

*All sizes in CM*

Model	Length	Depth	Height
Main Table 1	120	60	75
Main Table 2	135	60	75
Back Unit 1	235	50	180
Back Unit 2	165	50	180
	180	50	180
Back Unit 3	165	50	115
	180	50	115
	235	50	115
Back Unit 4	165	50	75
	180	50	75
	235	50	75

**Colour Swatch**



**MB112 -**  
Tobacco Ash  
+ LM01  
Black Ink



**LM93 -**  
Palau teak  
+ LM01  
Black Ink  
(Table 1)

*Design Registered*

DESKING/Office Desks/ **Topaz**



**Features:**

- Clean lines and surfaces enhance the overall look, blending well with raw wood grain and aesthetic door handles
- Simple geometric lines throughout the panel with optimum use of lighter shades, highlight neatness
- A unique pattern on the fascia and modesty panel ups the style quotient

**Line Diagram**

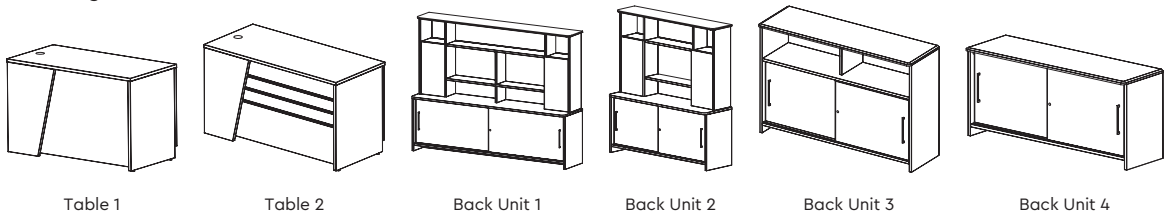

**Specification**

*All sizes in CM*

Model	Length	Depth	Height
Main Table 1	120	60	75
Main Table 2	135	60	75
Back Unit 1	235	50	180
Back Unit 2	165	50	180
	180	50	180
Back Unit 3	165	50	115
	180	50	115
	235	50	115
Back Unit 4	165	50	75
	180	50	75
	235	50	75

**Colour Swatch**





**Features:**

- Inspired by the grace of Swan, the flowing design of return unit blends seamlessly into the main table. The contrasting colors aesthetically highlight the same
- The flowing lines continue on the modesty with a slanted cut to the panel that perfectly complements the return unit

**Line Diagram**

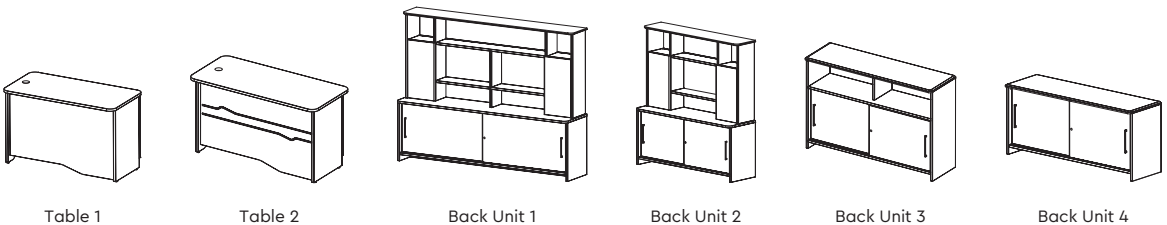

**Specification**

All sizes in CM

Model	Length	Depth	Height
Main Table 1	120	60	75
Main Table 2	135	60	75
Back Unit 1	235	50	180
Back Unit 2	165	50	180
	180	50	180
Back Unit 3	165	50	115
	180	50	115
	235	50	115
Back Unit 4	165	50	75
	180	50	75
	235	50	75

**Colour Swatch**

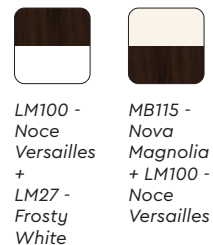

DESKING/Office Desks/ **Enzo**



**Features:**

- Aesthetic and functional all-wood design
- Variable drawer combos flex as per user's needs
- Added safety with lockable drawers

**Line Diagram**

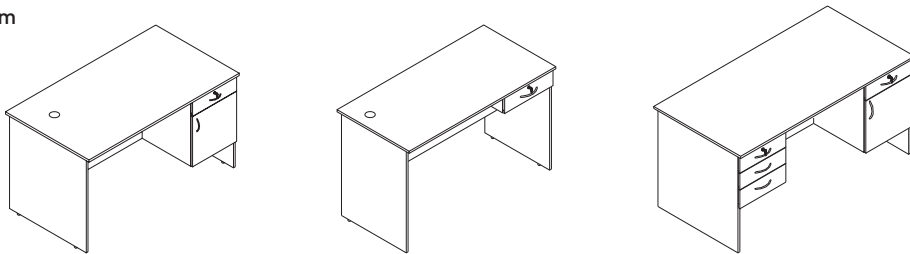

**Specification**

*All sizes in CM*

Model	Length	Depth	Height
Enzo	135	75	75
	120	60	75
	150	75	75

**Colour Swatch**



*Bavarian  
Beech*



# DESKING

CONFERENCE TABLES



## DESKING/Conference Tables/ **Mingle – Modular**



### Features:

- No restriction on number of seat, Each module can be connected with each other to create own configuration to accommodate number of users
- Unique modules designed to give ample leg space
- Clutter free top with provision of power module below work top
- Equipped with cable holders for easy access and keeping cables tangle free
- The worktops with grooves to enhance the look, at the same time serve as pen holders
- Available in PLT and MEM options

All sizes in CM

### Line Diagram

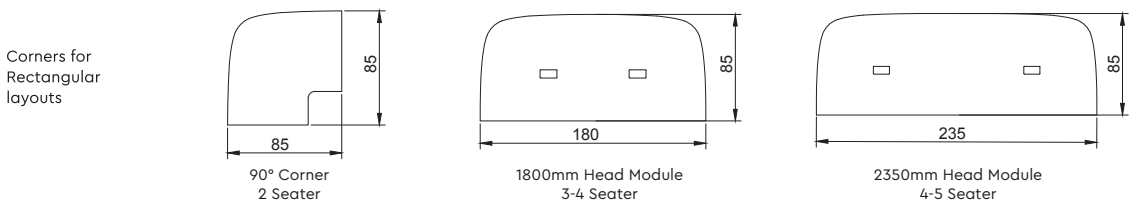
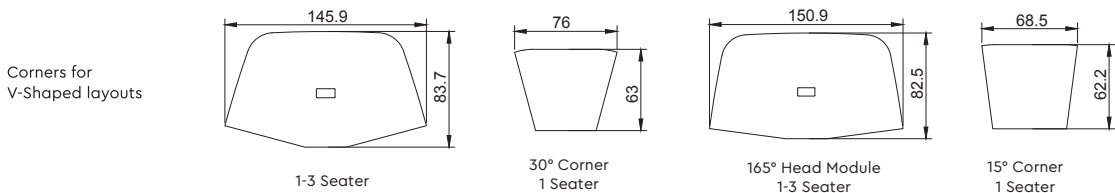
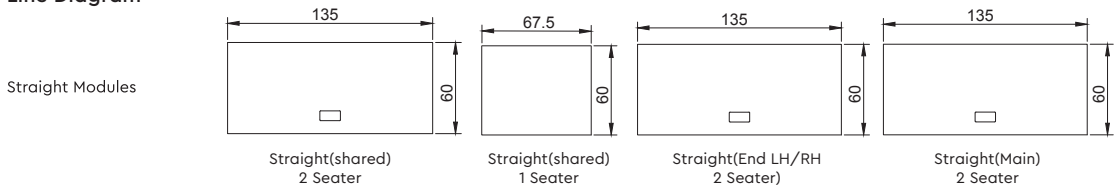

Open Layout

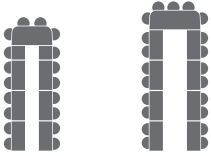

H1 Head Module H2 Head Module

Closed Layout

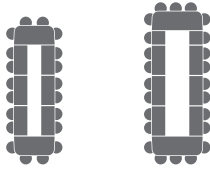

H1 Head Module H2 Head Module

Open Layout



Layout using V1 and V2 Head Module

Closed Layout



Closed Layout using Corner Module

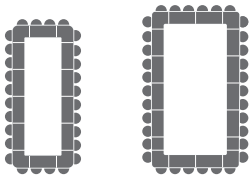

Open Layout using Corner Module

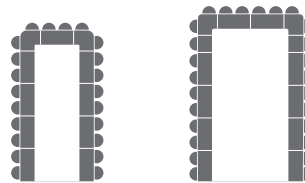

Colour Switch

PLT Range



*Siam Teak*



*Palau Teak*

Membrane Range



*Amati PC*



*Verade Oak  
Soft Natural*

# DESKING/Conference Tables/ **Mingle – Elegance AV**



**Features:**

- No restriction on number of seat, Each module can be connected with each other to create own configuration to accommodate number of users
- it can be Integrated with cable cubby and retractors
- Full length soft closing wooden access flap for easy power and data access
- Cantilever module design to give ample leg space to user

All sizes in CM

**Line Diagram**

Straight Modules

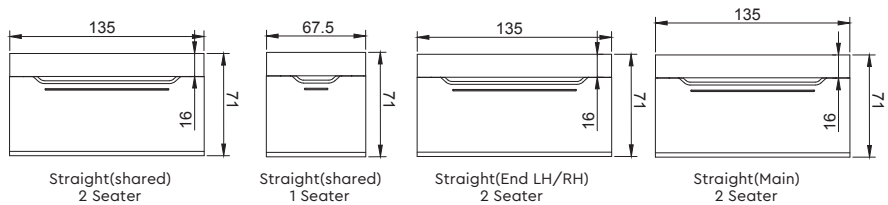

Corners for V-Shaped layouts

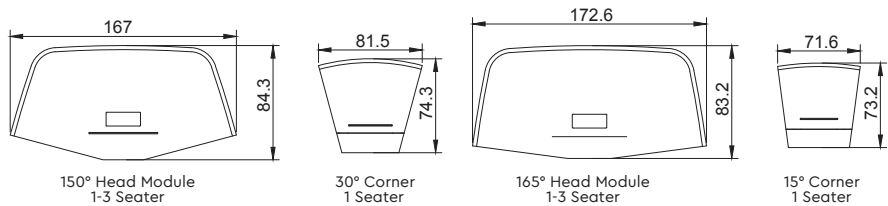

Corners for Rectangular layouts

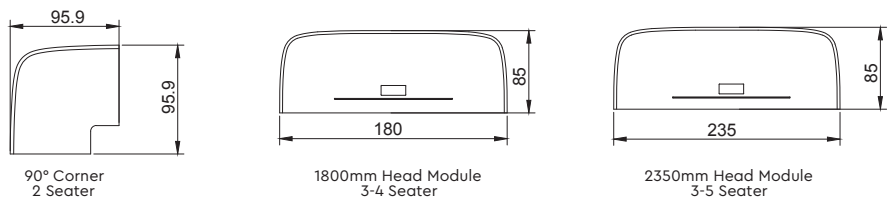

All sizes in CM

Open Layout

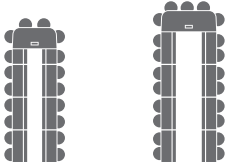

H1 Head Module H2 Head Module

Closed Layout

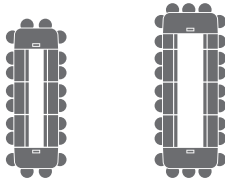

H1 Head Module H2 Head Module

Open Layout



Layout using V1 and V2 Head Module

Closed Layout

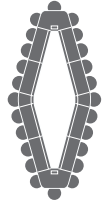

Closed Layout using Corner Module

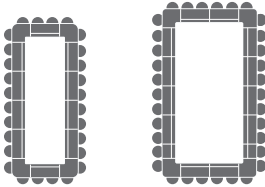

Open Layout using Corner Module

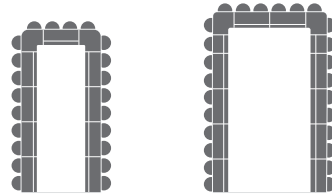

**Colour Swatch**



Tobacco Ash +  
Orchidea Nera  
Supermatt

## DESKING/Conference Tables/ **Mingle – Unitized**



**Features:**

- The table equipped soft closing wooden access flap for easy power and data connectivity
- The table equipped with Integrated cable cubby and retractor provision (AV Range only)
- Designed with clutter free top with concealed wire management
- Worktop shape to maintain optimum screen view angle for user
- Unitized available in PLT and MEM options, Unitized AV available in MEM option.



*All sizes in CM*

**Line Diagram**

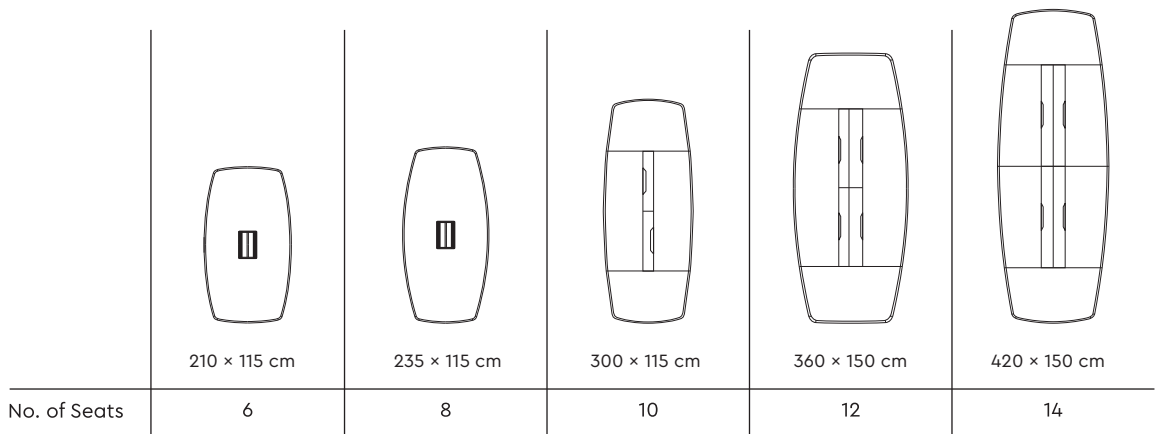
**PLT & Membrane Range**

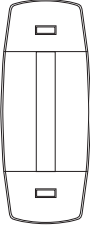
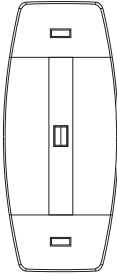
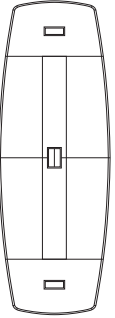

AV Range

					
	210 × 115 cm	235 × 115 cm	300 × 115 cm	360 × 150 cm	460 × 150 cm
No. of Seats	6	8	10	12	14

Colour Switch

PLT Range



Siam Teak



Palau Teak

Membrane Range & AV



Tobacco Ash



Verade Oak  
Soft Natural

## DESKING/Conference Tables/ **Mingle – Gather**



**Features:**

- Contemporary design and aesthetics to suit modern workspaces
- Power module provision at central easy access of power and data connectivity
- Gather feature range of accessories which brings life to workspace to feel more engaged and connected to workspace
- Available in PLT and MEM options

**Line Diagram**

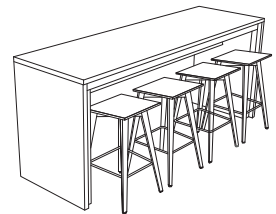
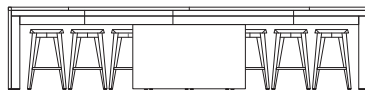
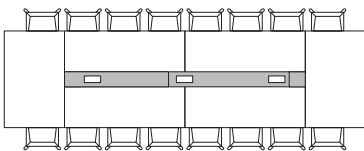

**Specification**

*All sizes in CM*

Model	Length	Depth	Height
4 Seater	230	80	105
10 Seater	320	120	105
16 Seater	500	120	105

**Colour Swatch**

PLT Range

Membrane Range



*Rimini*  
Walnut +  
Greystone  
Dark



*Nova*  
Magnolia +  
Rimini  
Walnut

DESKING/Conference Tables/ **Mingle – VC COLAB**



**Features:**

- AV integrated confenece tableto fulfill demand of Digitalization era
- Designed for maximum utilization of space without any special requirement of Video conferencing room; it can also be used in office to make it more collaborative
- Concealed wire management: It has hidden channels to route enough wires to add advanced AV systems to the room
- Soft closing dual access flap provided for access to power supply and data cables
- The unique worktop shape ensures that users stay within optimal viewing experience
- Aesthetically design worktop with waterfall edge
- Provision of Floor test for high seating option

**Line Diagram**

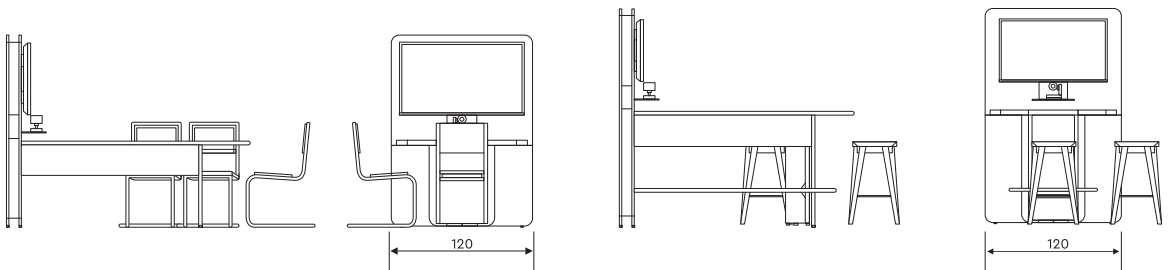

**Specification**

All sizes in CM

Model	Length	Depth	Height
Standard Seating	210	122	164
High Seating	210	122	192

**Colour Swatch**



Nova Magnolia +  
Noce Versailles



DESKING/Conference Tables/ **Mingle – POD**



**Features:**

- The table equipped access flap on worktop for easy power and data connectivity
- Designed with clutter free top with concealed wire management
- Worktop shape to maintain optimum screen view angle for user
- Available in PLT and MEM options

**Line Diagram**

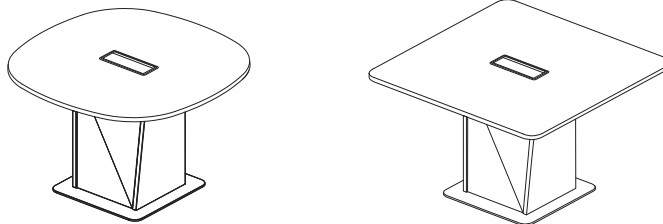

**Specification**

*All sizes in CM*

Model	Length	Depth	Height	DIA
Circular			74	100
			74	115
Square	100	100	74	
	115	115	74	

**Colour Switch**

**PLT Range**



*Siam Teak*



*Palau Teak*



*Greystone Dark*  
*(Only available with 115cm Dia)*

**Membrane Range**



*Tobacco Ash*

DESKING/Conference Tables/ **Conclave**



**Features:**

- Classy and sophisticated, black-back painted glass top with 12 mm thick toughened glass
- Plug-and-play data and power points for individual users with in-built concealed wire management for neat looks and uninterrupted conferencing
- Additional concealed storage to keep conferencing material during discussions, to avoid worktop clutter

**Line Diagram**

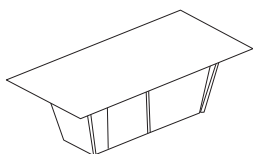

8 Seater  
(Straight Top)

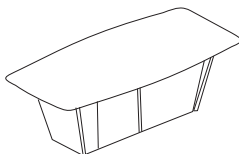

8 Seater  
(Curvilinear)

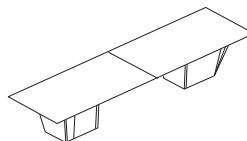

10-14 Seater  
(Straight Top)

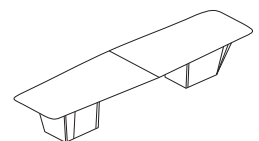

10-14 Seater  
(Curvilinear Top)

**Specification**

*All sizes in CM*

Model	Length	Depth	Height
8 Seater Curve/straight	240	120/150	75
10 Seater Curve/straight	320	120/150	75
12 Seater Curve/straight	400	120/150	75
14 Seater Curve/straight	480	120/150	75

**Colour Swatch**



LM01-Black Ink



# DESKING

TRAINING TABLES

DESKING/Training Tables/ **Unlearn**



**Features:**

- It has 3 Base units that can make a single, double, triple or a 6 seater table
- Table height is low to ensure visibility of the instructor during training is not hindered due to the PC or laptop
- Well designed wire management ensures ample leg space and clean under table environment
- Access Flap mounted on the tabletop enables easy access to plug points
- Sleek table with sleek legs ensure minimum use of space and also makes the table look light and aesthetic

**Line Diagram**

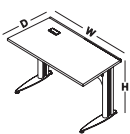

Unlearn One Seater  
(Desktop / Laptop)

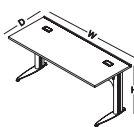

Unlearn Two Seater (Laptop)

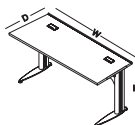

Unlearn Two Seater (Desktop)

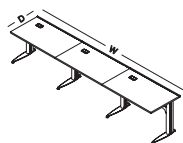

Unlearn Three Seater  
(Desktop / Laptop)

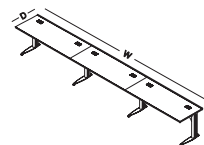

Unlearn Six Seater

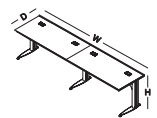

Unlearn Four Seater

**Specification**

All sizes in CM

Model	Length	Depth	Height
One Seater (Desktop/Laptop)	90	60	68
Two Seater (Laptop)	135	60	68
Two Seater (Desktop)	150	60	68
Three Seater (Desktop/Laptop)	270	60	68
Six Seater (Desktop)	450	60	68
Six Seater (Laptop)	405	60	68
Four Seater (Desktop)	300	60	68
Four Seater (Laptop)	270	60	68

**Colour Swatch**



LM91 - Malaga Cherry (Top) + LM03 - Cement Grey (Modesty)



LM59 - Petrol Blue (Top) + LM03 - Cement Grey (Modesty)



LM104 - Kitami Elm (Top) + LM03 - Cement Grey (Modesty)

DESKING/Cafeteria and Breakout Areas/ **Flip NXT**

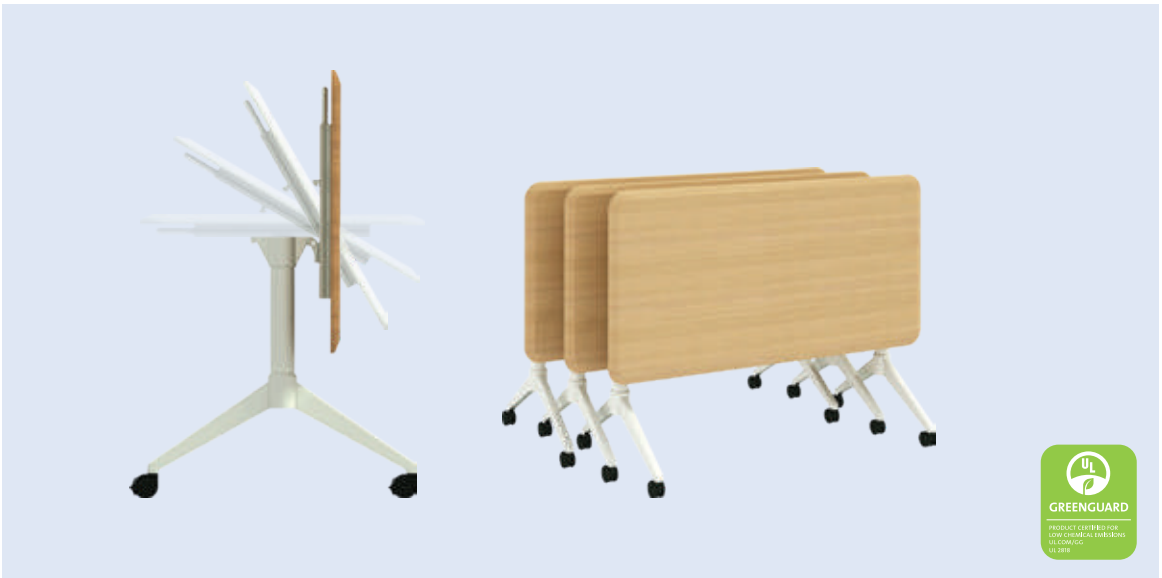

**Features:**

- Flip it up and get more space, flip it down and get to work • Easy to access operating handle to flip the table
- Castors with 360-degree movement to align with direction of motion • Sleek and lightweight design with rounded corner of worktop to avoid injury • Unique design of legs and understructure blend with aesthetic of office

**Line Diagram**

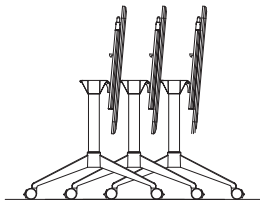

Stacked condition

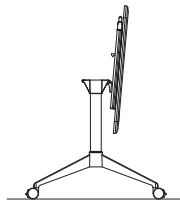

Fold up condition

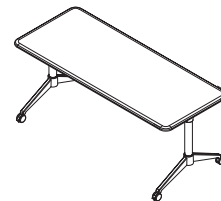

**Specification**

All sizes in CM

Model Flip NXT	Length	Depth	Height
2 seater	120	60	75
2 seater	135	60	75
4 seater	150	75	75
4 seater	165	75	75
6 seater	180	75	75

**Colour Swatch**



Ferrera Oak (MEM)



Green (PU)



RAL White (PU)



# DESKING

CAFETERIA AND BREAKOUT AREAS

DESKING/Cafeteria and Breakout Areas/ **Cafe Pod**



**Features:**

- Design provides clean and hygienic cafeterias
- Folding design
- Horizontal stacking
- Serrated Stainless Steel pedestal for aesthetics and sturdiness

**Line Diagram**



**Specification**

*All sizes in CM*

Model	Length	Depth	Height
Rubber Wood Top	80	80	73.80
Stainless Stool Top	80	80	74.25
PU Top	80	80	74.50

**PU Top**



**Rubber Wood Top**

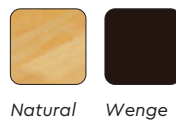

**Stainless Steel Top**



DESKING/Cafeteria and Breakout Areas/ **Time Out**



**Features:**

- It is sleek & stackable to ensure better space management for the user
- It has a wide range of colours available that are suitable for both trendy & traditional meal spaces
- Also available in PU Coated top & Membrane top
- Options of 4, 6 & 8 seater configurations gives ample choice to the user as per his requirement

**Line Diagram**

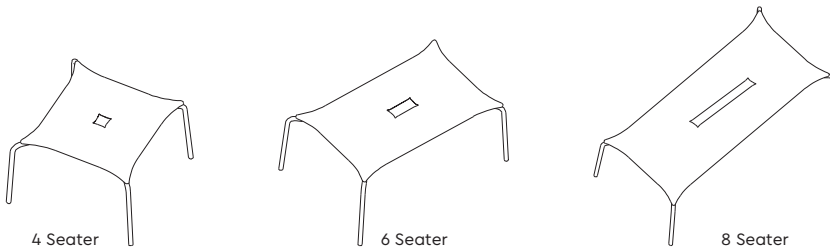

**Specification**

*All sizes in CM*

Model	Length	Depth	Height
4 Seater	113.50	117.50	75
6 Seater	173.40	117.50	75
8 Seater	232.90	117.50	75

**Colour Swatch**

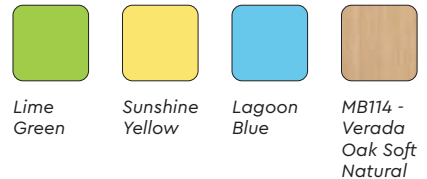



DESKING/Cafeteria and Breakout Areas/ **Flip NXT**

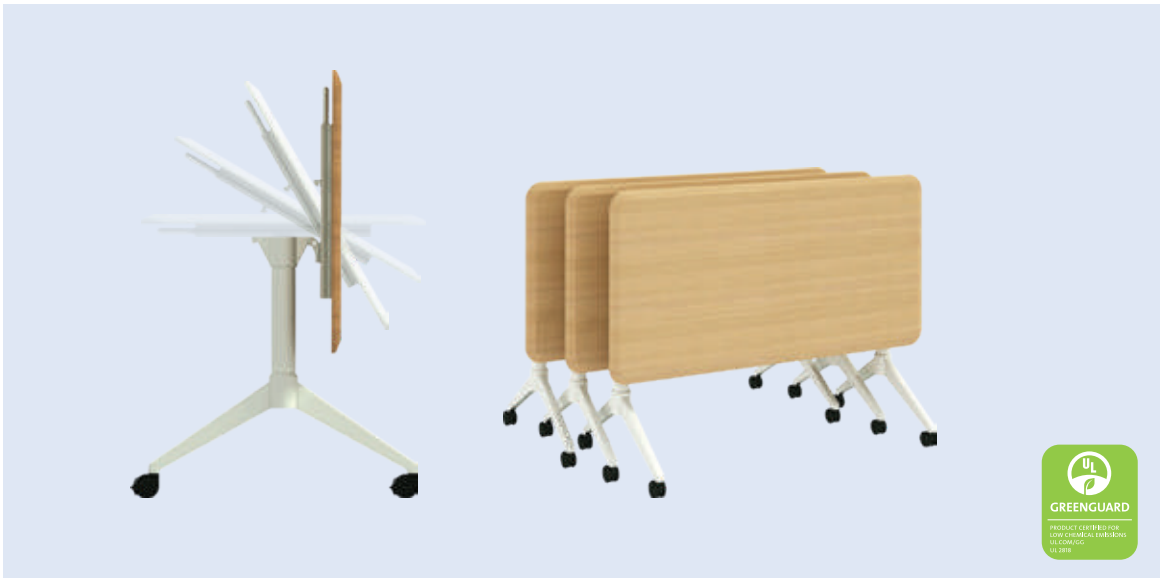

**Features:**

- Flip it up and get more space, flip it down and get to work • Easy to access operating handle to flip the table
- Castors with 360-degree movement to align with direction of motion • Sleek and lightweight design with rounded corner of worktop to avoid injury • Unique design of legs and understructure blend with aesthetic of office

**Line Diagram**

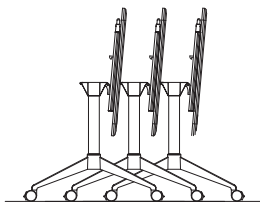

Stacked condition

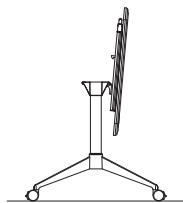

Fold up condition

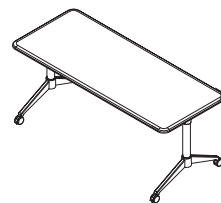

**Specification**

*All sizes in CM*

Model Flip NXT	Length	Depth	Height
2 seater	120	60	75
2 seater	135	60	75
4 seater	150	75	75
4 seater	165	75	75
6 seater	180	75	75

**Colour Swatch**



*Ferrera Oak (MEM)*



*Green (PU)*



*RAL White (PU)*



# SEATING

LEATHER AND LETHERETTE

SEATING/Leather and Leatherette Chairs/ **La Sede**



**Features:**

- **HEIGHT ADJUSTABLE BACK:** The contoured lumbar area can be adjusted to suit your back profile by adjusting the back height
- **T-SPINE STRUCTURE:** This supports the contoured chair back, providing flexibility in the back height adjustment
- **HEIGHT ADJUSTABLE ARMS:** The wide, soft edged PU top armrests provide complete support to elbows and forearms. The height of armrests can be adjusted as per need
- **ACTIVE BIO-SYNCHRO MECHANISM:** The Active Bio-Synchro mechanism senses your body weight and tilts accordingly even as the seat glides in tandem with the back. This provides full contact and continuous support to the back in all tilt positions. The chair comes with 5 position tilt limiter
- **SEAT DEPTH ADJUSTMENT:** The seat depth adjustment helps fit different body types

**Line Diagram**

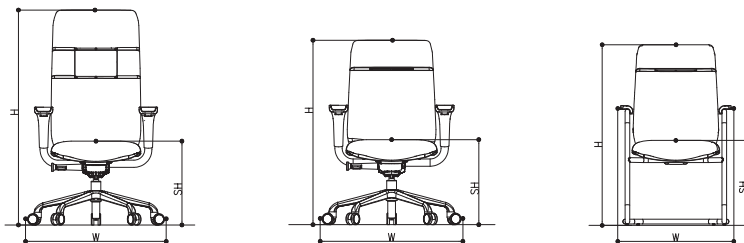

**Specification**

*All sizes in CM*

Model	Length	Depth	Height	Seat Height
High Back	76.10	76.10	114-131.50	44.50-54.50
Mid Back	76.10	76.10	96.50-114	44.50-54.50
Visitor	60.90	64.70	98.20	46.20

**Colour Swatch**

LT01	LT52	LT80	LT50
------	------	------	------

SEATING/Leather and Leatherette Chairs/ **Marvel**



**Features:**

- **HEIGHT ADJUSTABLE BACK:** The contoured lumbar area can be adjusted to suit your back profile by adjusting the back height
- **T-SPINE STRUCTURE:** This supports the contoured chair back, providing flexibility in the back height adjustment
- **HEIGHT ADJUSTABLE ARMS:** The wide, soft edged PU top armrests provide complete support to elbows and forearms. The height of armrests can be adjusted as per need
- **ACTIVE BIO-SYNCHRO MECHANISM:** The Active Bio-Synchro mechanism senses your body weight and tilts accordingly even as the seat glides in tandem with the back. This provides full contact and continuous support to the back in all tilt positions. The chair comes with 5 position tilt limiter
- **SEAT DEPTH ADJUSTMENT:** The seat depth adjustment helps fit different body types

**Line Diagram**

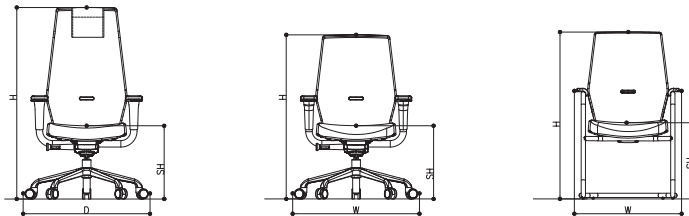

**Specification**

All sizes in CM

Model	Length	Depth	Height	Seat Height
High Back	76.10	76.10	112.70-130.20	43.10-53.10
Mid Back	76.10	76.10	96.50-114	43.10-53.10
Visitor	60.90	64.20	98.20	44.80

**Colour Swatch**

LC01	LC53	LC50	LC52
------	------	------	------

SEATING/Leather and Leatherette Chairs/ **Versa Neo**



**Features:**

- **HEIGHT ADJUSTABLE BACK:** The contoured lumbar area can be adjusted to suit the user's back profile by adjusting the back height
- **COMFORTABLE AND HEALTHY SEATING:** Designed with an ergonomic contour, these provide form-fitting lumbar support ensuring comfort and healthy seating
- **T-SPINE STRUCTURE:** This supports the contoured chair back, providing flexibility in the back height adjustment
- **HEIGHT ADJUSTABLE ARMS:** A personalized arm support with wide PU top arms offers firm support while performing any task. The wide PU Armrest ensures comfortable elbow rest without the need for swivel
- **ACTIVE BIO SYNCHRO MECHANISM:** An auto back-tilt tension adjustment. This is based on a user's body weight in which the seat 'glide' function during tilting ensures proper lower back support
- **SEAT DEPTH ADJUSTMENT:** This allows the seat to be adjusted in a forward or backward position, enabling long-term comfort while performing multi-role tasks

**Line Diagram**

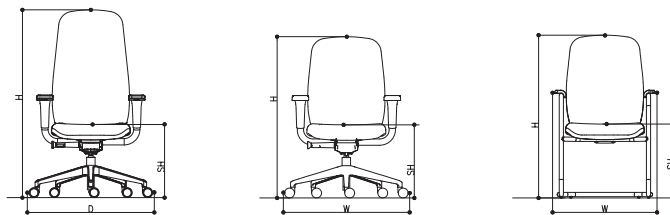

**Specification**

Model	Length	Depth	Height	Seat Height
High Back	76.10	76.10	113.60-131.10	44.40-54.40
Mid Back	76.10	76.10	98.60-116.10	44.40-54.40
Visitor	60.90	64.30	99.50	44.80

All sizes in CM

**Colour Swatch**

SF51 + LC01

SEATING/Leather and Leatherette Chairs/ **Sedna**



**Features:**

- Leather upholstery for luxurious touch and feel
- Pneumatic seat height adjustment
- Chrome finish fixed armrest
- Back height adjustment
- Synchronous tilt mechanism
- Multi-position locking
- Anti Shock mechanism
- 5 pronged die cast aluminium pedestal

**Line Diagram**

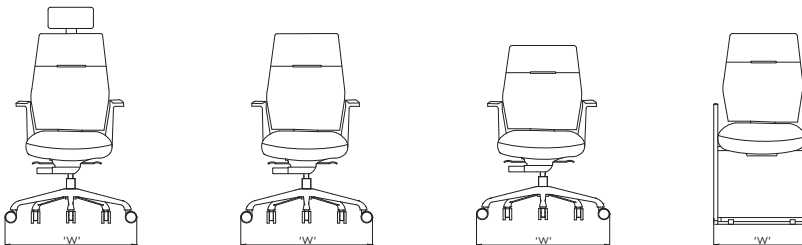

**Specification**

*All sizes in CM*

Model	Length	Depth	Height	Seat Height
High Back (with Headrest)	75	75	113.50-138	41-51
High Back (without Headrest)	75	75	101-118	41-51
Mid Back	75	75	93.50-110.50	41-51
Visitor	51	66.50	96	48

**Colour Swatch**

LT01	LT50	LT80
------	------	------

SEATING/Leather and Leatherette Chairs/ **Beat**



**Features:**

- Back height adjustment has a lever-less, drop-lift function for intuitive height adjustment while seated
- The trapezoidal back enables easy grip for back height adjustment
- Backrest adjustment and optional seat depth adjustment helps accommodate different body types
- The button underneath the arm pad enables arm height adjustment
- Multiple locking positions make it suitable for different tasks
- Contoured surfaces maximize body contact area and therefore maximize comfort
- Wide upper back and contoured seat ensures a comfortable seating experience
- Waterfall seat edge reduces pressure behind the knees, encouraging blood circulation

**Line Diagram**

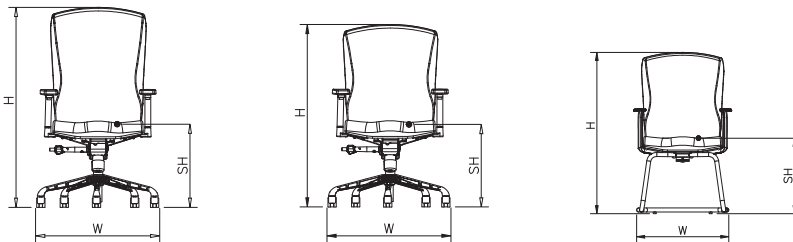

**Specification**

*All sizes in CM*

Model	Length	Depth	Height	Seat Height
High Back	75	75	102-119	45-55
Mid Back	75	75	92-110	45-55
Visitor	57.50	58.20	100.80	47

**Colour Swatch**

LC01	LC53	LC50	LC52
FK01	FK07	FK04	

SEATING/Leather and Leatherette Chairs/ **Kareena NXT**



**Features:**

- Leather upholstery for luxurious touch and feel
- Pneumatic seat height adjustment
- Chrome finish fixed armrest
- Back height adjustment
- Synchronous tilt mechanism
- Multi-position locking
- Anti Shock mechanism
- 5 pronged die cast aluminium pedestal

**Line Diagram**

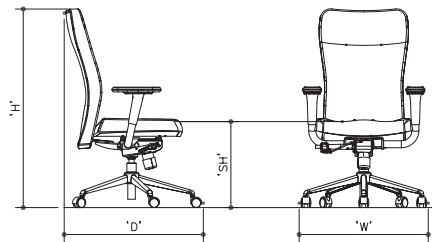

**Specification**

Model	Length	Depth	Height	All sizes in CM	
				Seat Height	
High Back (with Headrest)	75	75	113.50-138	41-51	
High Back (without Headrest)	75	75	101-118	41-51	
Mid Back	75	75	93.50-110.50	41-51	
Visitor	51	66.50	96	48	

**Colour Swatch**

FC18	FC06	FC42	FC64	FC01
FC04	FC07	LC01	LC53	LC50
LC52	FC22	FC24	FC12	FC14
FC25	FC08	FC16	FC02	FC10
FC03				



SEATING/Leather and Leatherette Chairs/ **Elite**



**Features:**

- Quilted Leatherette chair • Height adjustable lumbar support - ample support to lumbar area for different body size and height
- Height adjustable armrest for better comfort • Provision for coat hanger • Two seat depth for different body structure
- 4 Position locking mechanism • Chrome pedestal

**Line Diagram**

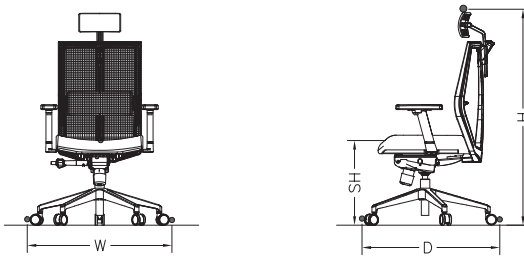

**Specification**

Model	Length	Depth	Height	Seat Height
High Back	76.10	76.10	114.0 - 128.2	44.0 - 54.0

*All sizes in CM*

**Colour Swatch**

LC01- Black Ink



# SEATING

MESH BACK CHAIRS

SEATING/Mesh Back Chairs/**Greta**



**Features:**

- Workstation chair with minimalistic design and aesthetics lend office spaces subtle sophistication and style
- It comes with several in-built ergonomic adjustments that make for an elevated user experience
- Adjustable lumbar support, headrest, armrests, multiple back lock and back tilt positions and adjustable seat height ensure comfort throughout the day
- Built to the most stringent performance and quality testing protocols conforming to BIFMA X5.1 standard.

**Line Diagram**

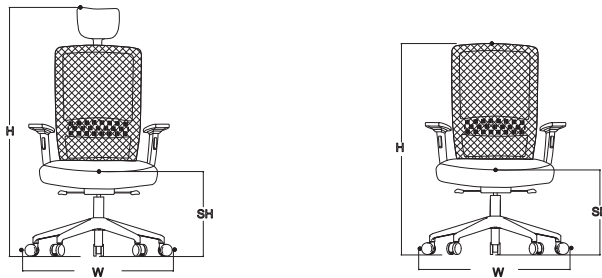

**Specification**

*All sizes in CM*

Model	Length	Depth	Height	Seat Height
High Back	76	76	114-123.50	43.50-54
Mid Back	76	76	95.50-105.50	43.50-54

**Colour Swatch**

*Grey Mesh back  
+ Grey Fabric seat*

SEATING/Mesh Back Chairs/ **Ace**

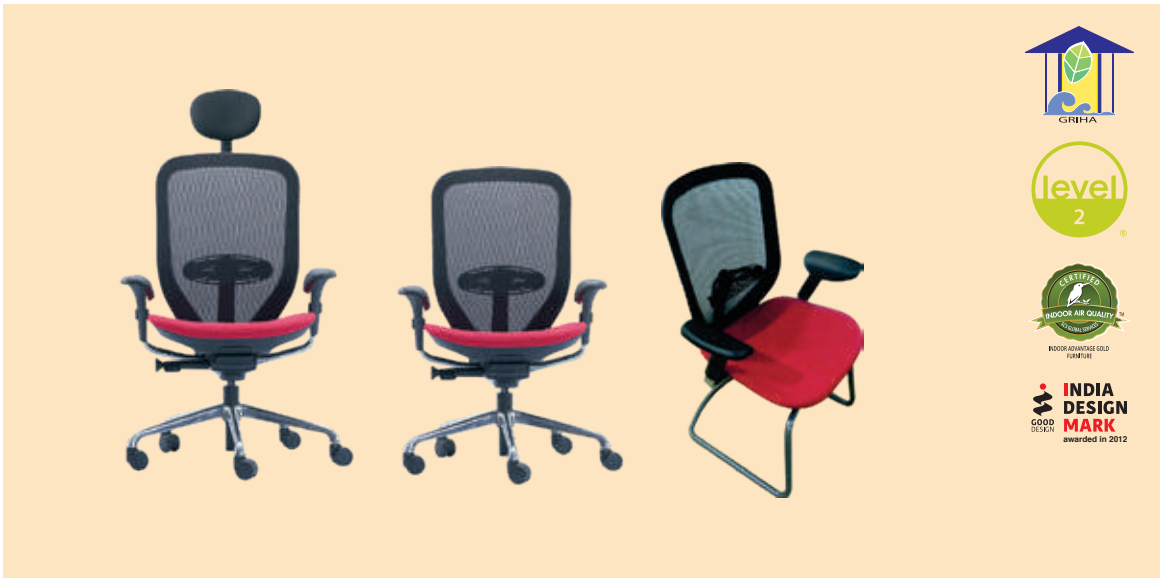

**Features:**

- Adjustable Neck Rest cushioned and contoured to provide adequate neck support
- The seat has a contoured foam to provide higher contact area and increased seating comfort
- The saddle support PU top adjustable armrests provide soft contours at all the touch points
- Specialised GREENGUARD compliant materials for healthy indoors
- 100% VOC free powder coating
- 98% recyclable
- Knock-down design reducing transportation emissions.

**Line Diagram**

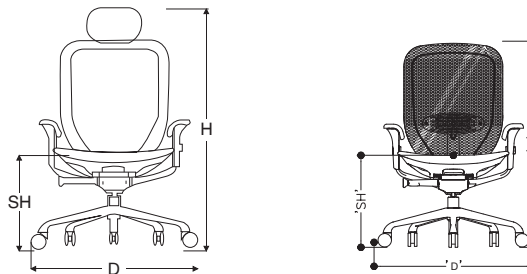

**Specification**

*All sizes in CM*

Model	Length	Depth	Height	Seat Height
3002AS (with Headrest)	75	75	109.30-124.40	45.50-55.50
3002AS	75	75	95.50-105.50	45.50-55.50
3002AC	70.50	70.50	99	49
3012AX	65.50	58.20	99.50	48.50

**Colour Swatch**

NM-Black Wave + FC18, FC06, FC02, FC10, FC03, FC16, FC42, FC64, FC01, FC04, FC07, FC22, FC24, FC12, FC14, FC25, FC08,	NM-Grey Checked + FC25, FC16, FC22, FC24, FC12, FC14, FC07, FC08, FC04, FC02, FC10, FC03, FC18, FC06, FC42, FC64, FC01,
---	--

Design Registered

SEATING/Mesh Back Chairs/ **Versa Mesh**



**Features:**

- **HEIGHT ADJUSTABLE BACK:** The contoured lumbar area can be adjusted to suit the user's back profile by adjusting the back height
- **T-SPINE STRUCTURE:** This supports the contoured chair back, providing flexibility in the back height adjustment
- **ACTIVE BIO SYNCHRO MECHANISM:** An auto back-tilt tension adjustment. This is based on a user's body weight in which the seat 'glide' function during tilting ensures proper lower back support
- **COMFORTABLE AND HEALTHY SEATING:** Designed with an ergonomic contour, these provide form-fitting lumbar support ensuring comfort and healthy seating
- **HEIGHT ADJUSTABLE ARMS:** A personalized arm support with wide PU top arms offers firm support while performing any task. The wide PU Armtop ensures comfortable elbow rest without the need for swivel
- **SEAT DEPTH ADJUSTMENT:** This allows the seat to be adjusted in a forward or backward position, enabling long-term comfort while performing multi-role tasks

**Line Diagram**

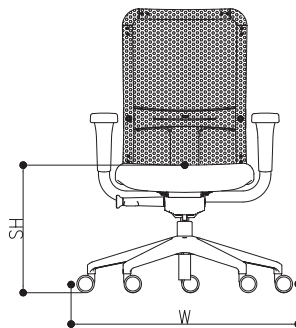

**Specification**

Model	Length	Depth	Height	Seat Height
High Back	76.10	76.10	97.30-114.80	43.60-53.60

*All sizes in CM*

**Colour Swatch**

FL01	FL07	FL06
------	------	------

SEATING/Mesh Back Chairs/ **Pulse**



**Features:**

- **ADJUSTABLE NECK REST:** Height as well as tilt adjustment gives perfect support to the neck while in a reclining position.
- **LUMBAR PAD ADJUSTMENT:** Multi Flex Active Lumbar support enhances user's comfort by allowing height adjustment appropriate to individual's lower back. The pad, covered with foam laminated fabric, is designed to be flexible which allows it to move with the user.
- **ARM HEIGHT ADJUSTMENT:** Gives adequate elbow support while working on the desk.
- **TWO SEAT DEPTHS:** Option of two seat depths ensures adequate comfort to users of all body types.
- **RECLINE LOCK:** Lock mechanism ensures that the chair continues to be in the locked position while reclining.

**Line Diagram**

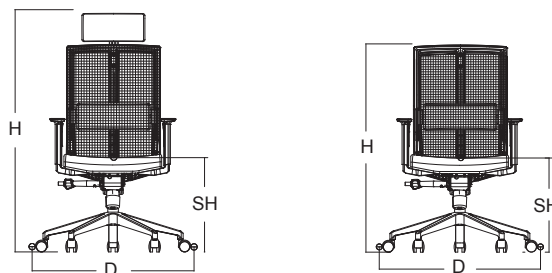

**Specification**

*All sizes in CM*

Model	Length	Depth	Height	Seat Height
High Back	76.10	76.10	114-128.20	44-54
Mid Back	76.10	76.10	98-108	44-54

**Colour Swatch**

FK18	FK01	FK04
------	------	------

SEATING/Mesh Back Chairs/**Oxbo**



**Features:**

- **Complete family of chairs :** High Back, Full Back and Visitor • Thicker Seat Cushion for SOLIDITY in style • Unique tubular frame back - DESIGNER touch • Mesh upholstery on back - TRENDY and LIGHT • Complimenting SLIM but WIDE Loop armrests

**Line Diagram**

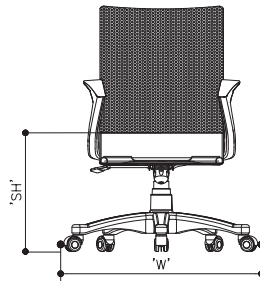

**Specification**

Model	Length	Depth	Height	Seat Height
High Back	76.30	76.30	99.50-110.50	43.30-54.30
Mid Back	76.30	76.30	89.50-100.50	43.30-54.30
Visitor	61	64.50	93.50	46.50

*All sizes in CM*

**Colour Swatch**

FC18	FC06	FC42	FC64
FC01	FC04	FC07	FC02
FC22	FC24	FC12	FC14
FC25	FC08	FC10	FC16
FC03			

SEATING/Mesh Back Chairs/ **Aero**



**Features:**

- Patterned Mesh chair • Height adjustable lumbar support – ample support to lumbar area for different body size and height
- Height adjustable armrest for better comfort • Provision for coat hanger • Two seat depth for different body structure
- 4 Position locking mechanism • Nylon pedestal

**Line Diagram**

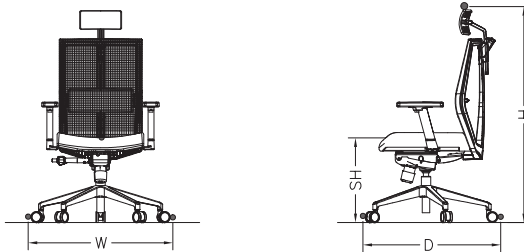

**Specification**

Model	Length	Depth	Height	Seat Height
High Back	76.10	76.10	114.0 - 128.2	44.0 - 54.0

*All sizes in CM*

**Colour Swatch**

*NM- Black checked*



SEATING/Mesh Back Chairs/**Cross**



**Features:**

- Chair with half Mesh and Half cushion fabric
- Height adjustable lumbar support - ample support to lumbar area for different body size and height
- Height adjustable armrest for better comfort
- Provision for coat hanger
- Two seat depth for different body structure
- 4 Position locking mechanism
- Nylon pedestal

**Line Diagram**

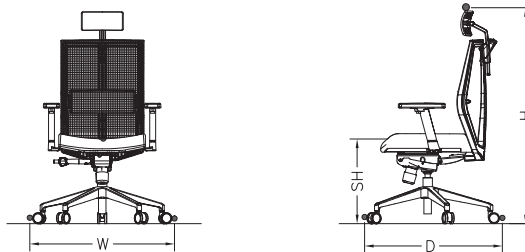

**Specification**

Model	Length	Depth	Height	Seat Height
High Back	76.10	76.10	114.0 - 128.2	44.0 - 54.0

*All sizes in CM*

**Colour Swatch**

*NM01-Black Micromesh*



# SEATING

CUSHION BACK CHAIRS

SEATING/Cushion Back chairs/ **Motion**



**Features:**

- Motion chair's EasyFlex is an innovative system that enables the user to adopt dynamic body movements while seated
- The unique flexing and spring back motion of this chair is a result of an evolved design construction and hi-tech compounded engineering plastics
- The seat and back of this chair are firmly connected to the base frame and are cantilevered in a way that allows multi-dimensional movement.

**Line Diagram**

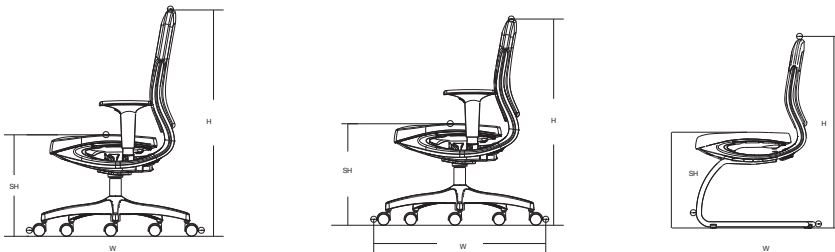

**Specification**

Model	Length	Depth	Height	Seat Height
High Back	76	76	99.50-108.80	44.50-53.80
Mid Back	76	76	90.50-99.80	44.50-53.80
Visitor	48.50	58.90	93.30	47.10

All sizes in CM

**Colour Swatch**

PL21-Sugar White + FK01, FK14, FK10, FK07, FS03	PL09-Cloud Grey + FK08, FK07, FK01 FK14, FK18
---	---

SEATING/Cushion Back chairs/ **Versa Canvas**



**Features:**

- **HEIGHT ADJUSTABLE BACK:** The contoured lumbar area can be adjusted to suit the user's back profile by adjusting the back height
- **T-SPINE STRUCTURE:** This supports the contoured chair back, providing flexibility in the back height adjustment
- **ACTIVE BIO SYNCHRO MECHANISM:** An auto back-tilt tension adjustment. This is based on a user's body weight in which the seat 'glide' function during tilting ensures proper lower back support
- **COMFORTABLE AND HEALTHY SEATING:** Designed with an ergonomic contour, these provide form-fitting lumbar support ensuring comfortable and healthy seating
- **HEIGHT ADJUSTABLE ARMS:** A personalized arm support with wide PU top arms offers firm support while performing any task. The wide PU Armtop ensures comfortable elbow rest without the need for swivel
- **SEAT DEPTH ADJUSTMENT:** This allows the seat to be adjusted in a forward or backward position, enabling long-term comfort while performing multi-role tasks

**Line Diagram**

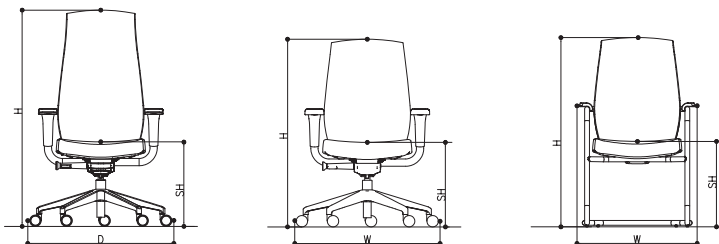

**Specification**

Model	Length	Depth	Height	Seat Height
High Back	76.10	76.10	113.40-130.90	44.20-54.20
Mid Back	76.10	76.10	96.30-113.80	44.20-54.20
Visitor	60.90	64.30	98.20	44.60

All sizes in CM

**Colour Swatch**

FL01	FL07	FL06
FL08	FL10	FL04
FL14		

SEATING/Cushion Back chairs/ **Versa Cushion**

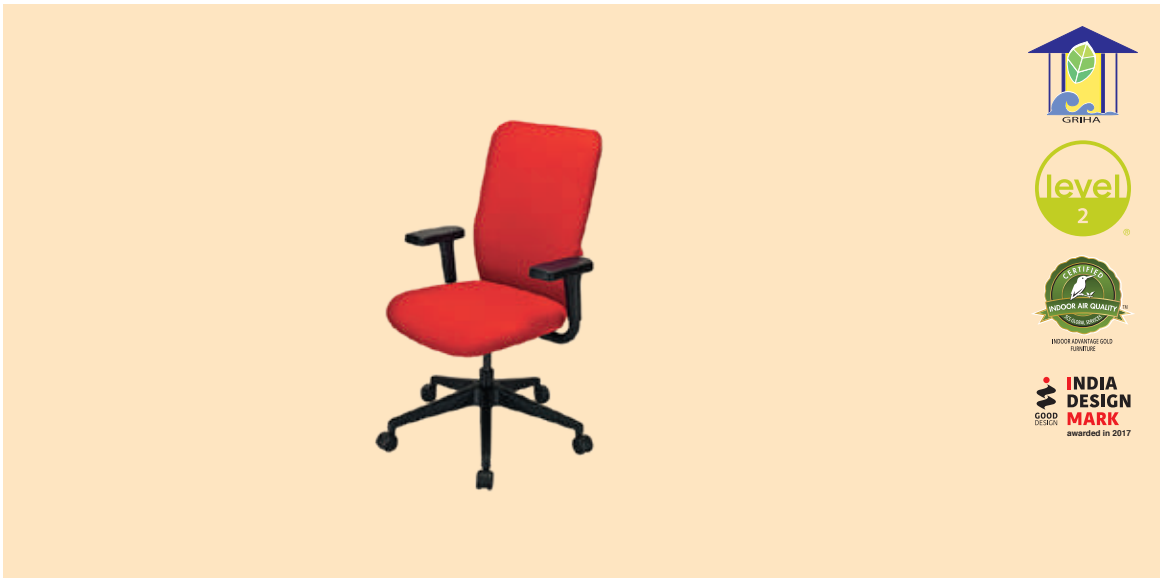

**Features:**

- **HEIGHT ADJUSTABLE BACK:** The contoured lumbar area can be adjusted to suit the user's back profile by adjusting the back height
- **T-SPINE STRUCTURE:** This supports the contoured chair back, providing flexibility in the back height adjustment
- **ACTIVE BIO SYNCHRO MECHANISM:** An auto back-tilt tension adjustment. This is based on a user's body weight in which the seat 'glide' function during tilting ensures proper lower back support
- **COMFORTABLE AND HEALTHY SEATING:** Designed with an ergonomic contour, these provide form-fitting lumbar support ensuring comfort and healthy seating
- **HEIGHT ADJUSTABLE ARMS:** A personalized arm support with wide PU top arms offers firm support while performing any task. The wide PU Armtop ensures comfortable elbow rest without the need for swivel
- **SEAT DEPTH ADJUSTMENT:** This allows the seat to be adjusted in a forward or backward position, enabling long-term comfort while performing multi-role tasks

**Line Diagram**

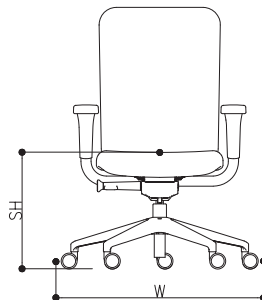

**Specification**

Model	Length	Depth	Height	Seat Height
Versa Chair	76.10	76.10	99.20-116.70	43.60-53.60

*All sizes in CM*

**Colour Swatch**

FL01	FL07	FL06
------	------	------

SEATING/Cushion Back chairs/ **Bravo**



**Features:**

- Thick cushion seat & back
- Wider contoured seat and back
- Centre Tilt Synchronous Mechanism with tilt tension adjustment
- Upright position
- Poly Propylene abuse resistive armrest
- 100% VOC free powder coating
- Designed for long life and easy part replacement.

**Line Diagram**

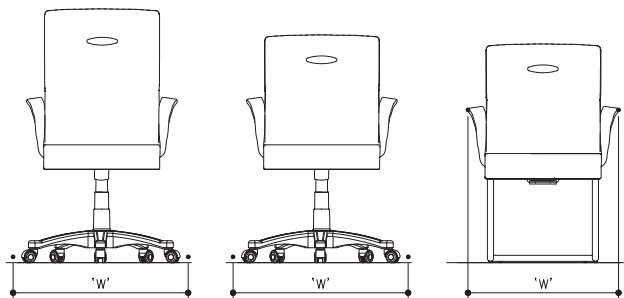

**Specification**

*All sizes in CM*

Model	Length	Depth	Height	Seat Height
High Back	76.30	76.30	97-109	42.50-54.50
Mid Back	76.30	76.30	85.50-97.50	42.50-54.50
Visitor	61.40	61.50	89.50	46.50

**Colour Swatch**

FC18	FC06	FC42	FC64
FC01	FC04	FC07	FC22
FC24	FC12	FC14	FC25
FC08	FC16	FC02	FC10
FC03			



# SEATING

TRAINING ROOM CHAIRS

SEATING/Training Room Chairs/ **Scintilla Desklet**



**Features:**

- **UNIQUE BACK-TILT:** A unique back-tilt feature allows an upright as well as relaxed angle, thus reducing pressure on the inter-vertebral discs during long training sessions.
- **MOTHER'S HUG:** Derived from the Mother's Hug, the body hugging contours comfortably supports you back.
- **LARGE CURVED FLIP-UP DESKLET:** The scratch-resistant large Flip-up desklet with been shaped inner curve makes the chair comfortable for different body types and supports analogue and digital resources.
- **BROAD ARMREST:** Scratch-resistant broad armrest ensures proper comfort to arms during long sitting hours.
- **BRAKE CASTERS:** Brake casters in the desklet version ensures firm grip on floor while one is seated and facilitates various room layouts unoccupied with its mobility.
- **HORIZONTAL STACKABILITY:** Tip-up seat ensures horizontal stackability thereby releasing used space for others' purposes.

**Line Diagram**

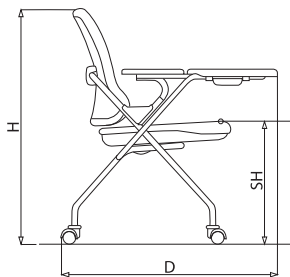

**Specification**

Model	Length	Depth	Height	Seat Height
Scintilla with desklet	66.50	84	89	47.50

*All sizes in CM*

**Colour Swatch**

FK61	FK07	FK04	FK02
FK08	FK18	FK03	FK10
FK01			



SEATING/Training Room Chairs/ **Unwind with desklet**



**Features:**

- **LIGHT AND PORTABLE:** Light-weight construction makes it easy to move around.
- **CUSHION-FRIENDLY:** Can accommodate a cushion to add to seating comfort.
- **STORAGE:** Sturdy wire basket to store your belongings.
- **ADJUSTABLE & NON-LIPPED DESK:** Desklet slides forward or backward to accommodate different size users.
- **EASY TO MAINTAIN:** Clean, flat surfaces make it easy to clean and maintain. The poly-propylene edging is in-situ injection moulded along with the desklet thereby preventing peel-off issues.

**Line Diagram**

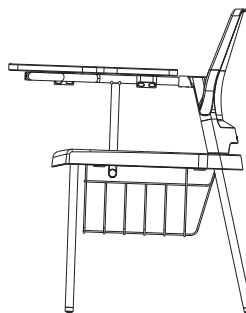

**Specification**

*All sizes in CM*

Model	Length	Depth	Height	Seat Height
With Desklet	57.50	67.80	84.50	45

**Colour Swatch**

Aqua Blue-021	Orchid White-022	Marigold Yellow-023
Raspberry Red-025	Fresh Lime-026	

*Design Registered*



# SEATING

MULTI-PURPOSE

SEATING/Multi-purpose/ **Unwind with armrest**



**Features:**

- **LIGHT AND PORTABLE:** Lightweight construction makes it easy to move around.
- **CUSHION-FRIENDLY:** Can accommodate a cushion to add to seating comfort.
- **STACKABLE:** Can be easily stacked to save more space.
- **EASY TO MAINTAIN:** Clean, flat surfaces make it easy to clean and maintain. The poly-propylene edging is in-situ injection moulded along with the desklet thereby preventing peel-off issues.

**Line Diagram**

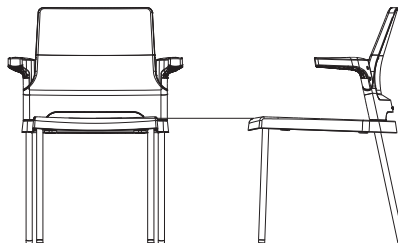

**Specification**

*All sizes in CM*

Model	Length	Depth	Height	Seat Height
With armrest	62.30	55.80	84.50	45

**Colour Swatch**

Aqua Blue-021	Orchid White-022	Marigold Yellow-023
Raspberry Red-025	Fresh Lime-026	

SEATING/Multi-purpose/ **Scintilla with and without armrest**



**Features:**

- **UNIQUE BACK-TILT:** A unique back-tilt feature allows an upright as well as relaxed angle, thus reducing pressure on the inter-vertebral discs during long training sessions
- **MOTHER'S HUG:** Derived from the Mother's Hug, the body hugging contours comfortably supports your back
- **BROAD ARMREST:** Scratch resistant broad armrest ensures proper comfort to arms during long sitting hours
- **BRAKE CASTERS:** Brake Casters in the desklet version ensures firm grip on floor while one is seated and facilitates various room layouts unoccupied with its mobility
- Adjustable anti slide footring to suit your seated height with comfort. Turning around feature to provide more collaborative workspace.

**Line Diagram**

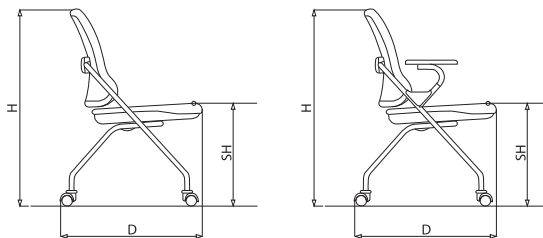

**Specification**

*All sizes in CM*

Model	Length	Depth	Height	Seat Height
Scintilla with arms	64.40	64.50	89	47.50
Scintilla without arms	64.40	64.50	89	47.50

**Colour Swatch**

FK01	FK07	FK04	FK02
FK08	FK18	FK03	FK10
FK01			



# SEATING

CAFETERIA & BREAK OUT CHAIRS

SEATING/Cafeteria & Breakout chairs/ **Unwind without armrest**



**Features:**

- **LIGHT AND PORTABLE:** Lightweight construction makes it easy to move around.
- **CUSHION-FRIENDLY:** Can accommodate a cushion to add to seating comfort.
- **STACKABLE:** Can be easily stacked to save more space.
- **EASY TO MAINTAIN:** Clean, flat surfaces make it easy to clean and maintain. The poly-propylene edging is in-situ injection moulded along with the desklet thereby preventing peel-off issues.

**Line Diagram**

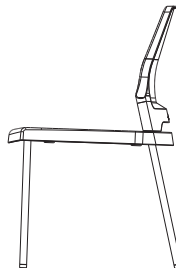

**Specification**

*All sizes in CM*

Model	Length	Depth	Height	Seat Height
MS and SS	52.50	55.80	84.50	45

**Colour Swatch**

Aqua Blue-021	Orchid White-022	Marigold Yellow-023
Raspberry Red-025	Fresh Lime-026	

SEATING/Cafeteria & Breakout chairs/ **Scintilla High Chair**



**Features:**

- **UNIQUE BACK-TILT:** A unique back-tilt feature allows an upright as well as relaxed angle, thus reducing pressure on the inter-vertebral discs during long training sessions
- **MOTHER'S HUG:** Derived from the Mother's Hug, the body hugging contours comfortably supports your back
- **BROAD ARMREST:** Scratch resistant broad armrest ensures proper comfort to arms during long sitting hours
- **BRAKE CASTERS:** Brake Casters in the desklet version ensures firm grip on floor while one is seated and facilitates various room layouts unoccupied with its mobility
- Adjustable anti slide footing to suit your seated height with comfort. Turning around feature to provide more collaborative workspace.

**Line Diagram**

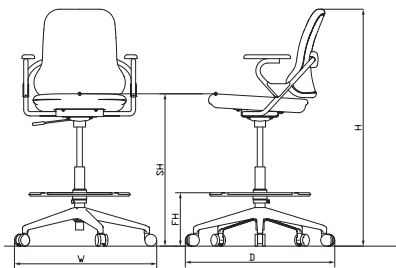

**Specification**

All sizes in CM

Model	Length	Depth	Height	Seat Height
with rolling castors	71.60	71.60	104.80-122.80	62-80
with fixed glides	71.60	71.60	101.90-119.90	59.10-77.10

**Colour Swatch**

FK61	FK07	FK04	FK02
FK08	FK18	FK03	FK10
FK01			

SEATING/Cafeteria & Breakout chairs/ **Unwind High Seating**



**Features:**

- **LIGHT AND PORTABLE:** Lightweight construction makes it easy to move around.
- **CUSHION-FRIENDLY:** Can accommodate a cushion to add to seating comfort.
- **EASY TO MAINTAIN:** Clean, flat surfaces make it easy to clean and maintain. The poly-propylene edging is in-situ injection moulded along with the desklet thereby preventing peel-off issues.

**Line Diagram**

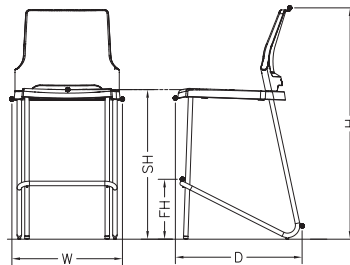

**Specification**

*All sizes in CM*

Model	Length	Depth	Height	Seat Height
MS and SS	52.50	60.40	113.40	74.00

**Colour Swatch**

Aqua Blue-021	Orchid White-022	Marigold Yellow-023
Raspberry Red-025	Fresh Lime-026	





# SEATING

BREAK OUT & COLLABORATIVE SEATING

SEATING/Break Out & Collaborative Seating/ **EezySit**



**Features:**

- Stylish design makes it look sleek and elegant
- Portable, foldable and lightweight, hence easier to carry
- Multi-purpose in function – can be used occasionally in office or at home
- Firm back support & twin layer breathable fabric for extra comfort

**Line Diagram**

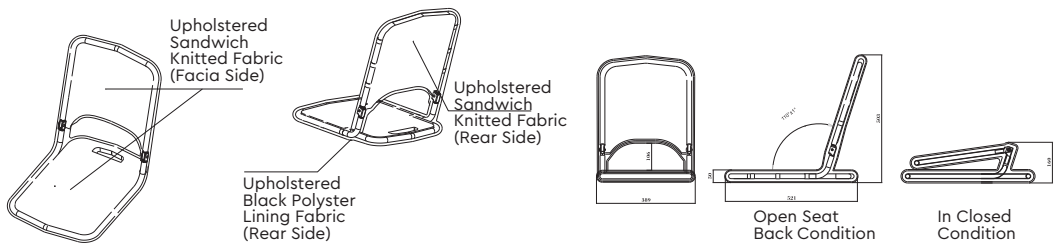

**Specification**

*All sizes in CM*

Model	Length	Depth	Height
Open	50.50	37.50	48
Closed	50.50	37.50	14

**Colour Swatch**

NM117      NM118



# SEATING

PUBLIC SEATING

SEATING/Public Seating/ **Matrix**



**Features:**

- Wide seat and ergonomic back form ensures relaxed posture. Seat shell has rounded edge profile eliminating sharp edges safety of user.
- It has 32 possible configurations that meet all types of needs. Also unique leaving shoe design with integrated aligners to adjust for uneven floors.
- Option for Hospital/Clinics: Anti-bacterial powder coating finish keeps product free of microbial growth and spreading infections.

**Line Diagram**

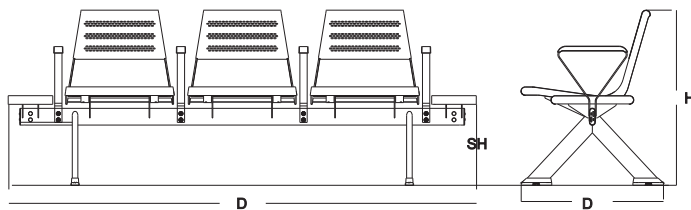

**Specification**

*All sizes in CM*

Model	Length	Depth	Height	Seat Height
MTX2XX/MTX2IX	114.50	63.80	78.50	44.10
MTX2XS/MTX2IS	155	63.80	78.50	44.10
MTX3XX/MTX3IX	169.50	63.80	78.50	44.10
MTX3XS	210	63.80	78.50	44.10
2 Seater	155	63.80	78.50	46.40

**Colour Swatch**

Powder coat - **LC53**  
Matt Taupe White



# SEATING

LOUNGE SEATING

SEATING/Lounge Seating/ **Midas**



**Features:**

- High Quality Chrome plated steel tubes
- Can withstand up to 1000 hrs of salty environment without rusting
- Stain-repellent, Abrasion-resistant fabric
- Changeable cushion covers

**Line Diagram**

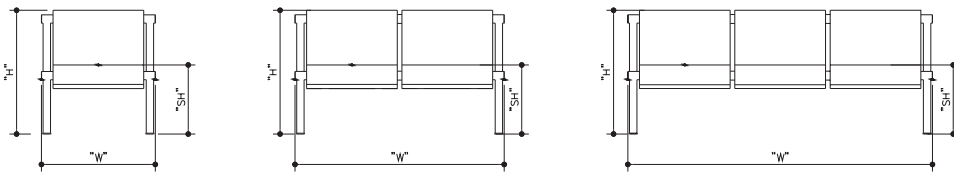

**Specification**

*All sizes in CM*

Model	Length	Depth	Height	Seat Height
Midas 1 Str	68.40	77.50	74.50	41.50
Midas 2 Str	125.70	77.50	74.50	41.50
Midas 3 Str	183	77.50	74.50	41.50

**Colour Swatch**

FP01	FP03	FP04
LC01		

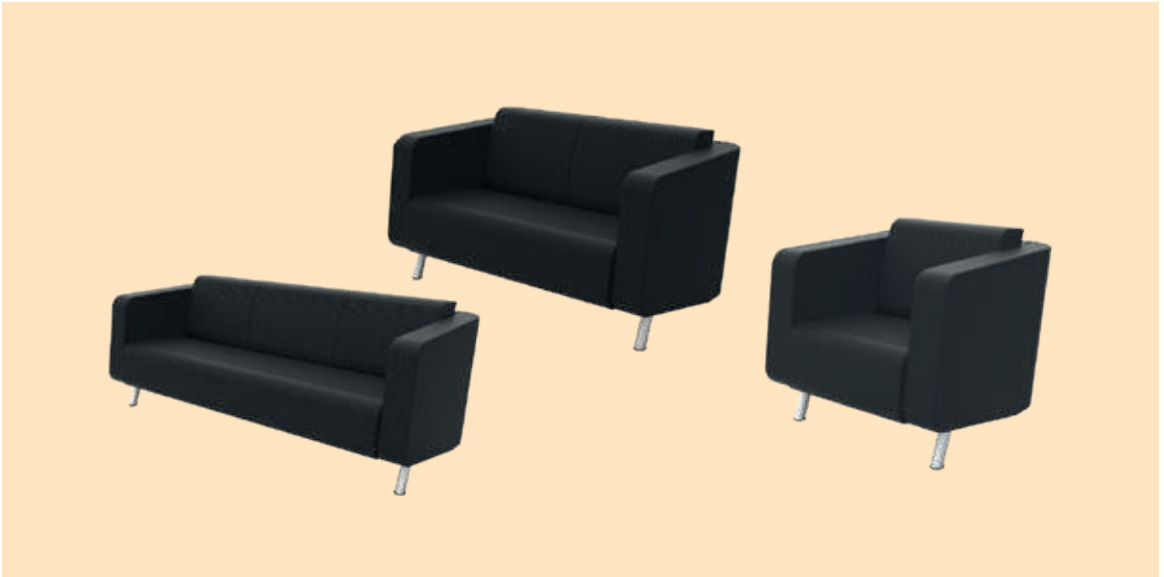

**Features:**

- Pisa is an office sofa, yet it gives a homely feel. Elegant, fresh and eye-catching with a style that's classically clean, it creates an inviting comfortable intimacy that puts people at ease so they can perform better. It gives ergonomic back support with a design based on Indian Anthropometric data.
- The Frame structure is made up of moisture, termite and borer resistant plywood. The spring assembly is attached on this plywood frame for additional cushioning purpose.
- Upholstered with soft, fine finish and durable shaneel fabric. The fabric has features like wear & tear resistance, colour fastness, high durability, soft touch and fine finish. Leatherette in Black colour is also available which is easy on maintenance.

**Line Diagram**

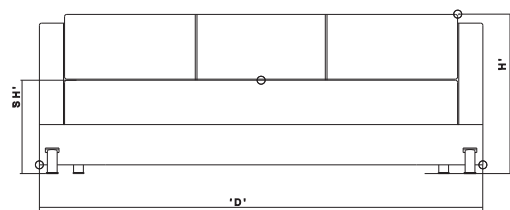
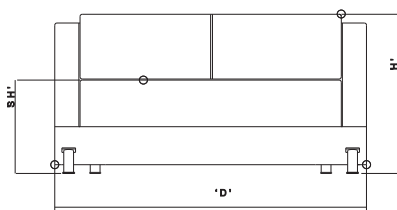

**Specification**

All sizes in CM

Model	Length	Depth	Height	Seat Height
1 Seater	86	90.50	85.50	45
2 Seater	146	90.50	85.50	45
3 Seater	206	90.50	85.50	45

**Colour Swatch**

FB18 (outer)+FB03 (inner)	FB04 (outer)+FB03 (inner)
FB51 (outer)+FB03 (inner)	LS01 (inner outer)
LS50 (inner outer)	LS08 (inner outer)



# SEATING

AUDITORIUM SEATING



SEATING/Auditorium Seating/ **Mars**

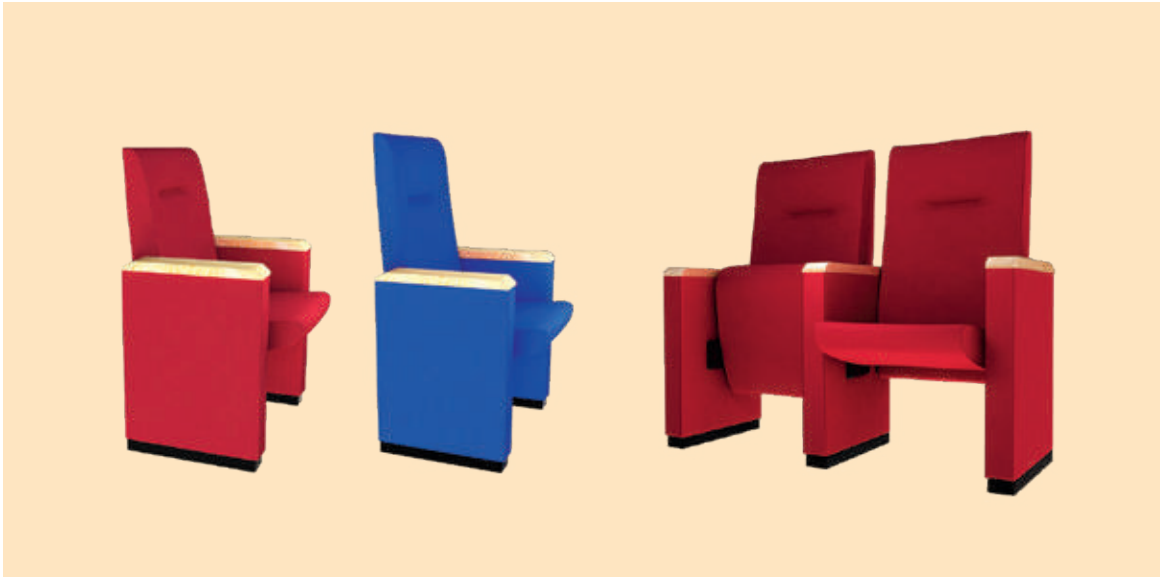

**Features:**

- **UPHOLSTERY:** The upholstery follows the seat and back contours through a unique stitching technique. This technique avoids glue usage over the fabric surface, thereby reducing VOC emissions.
- **AUTO SEAT TIP UP:** The seat tilts up when not in use, ensuring ease of movement between rows.
- **MECHANISM:** MARS is available with Flexi-back feature or Synchro Slide feature, ensuring the chair adjusts to the user's need.

**Line Diagram**

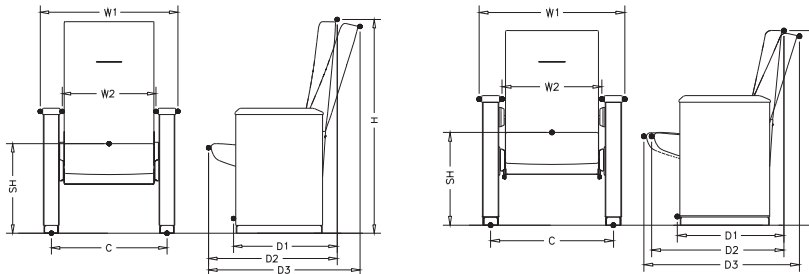

**Specification**

Model	Centre To Centre	Width (W1)	Width (W2)	Seat Height (SH)
Flexi-back (HB/MB)	58.70	67.50	50.70	45.50
	<b>Depth (D1)</b>	<b>Depth (D2)</b>	<b>Depth (D3)</b>	<b>Height (H)</b>
	50.50/50	63/62	77/73	107.30/95.30
Synchro Slide (HB/MB)	61	69.90	52.10	45.50
	<b>Depth (D1)</b>	<b>Depth (D2)</b>	<b>Depth (D3)</b>	<b>Height (H)</b>
	50.50/49.50	63/62	80/76.80	107.30/95.30

All sizes in CM

**Colour Switch**

FL01	FL07
FL06	FL08
FL10	FL04
FL56	

SEATING/Auditorium Seating/ **Eco Mars**



**Features:**

- PU Armrest with cup-holder which enables user to place their drinks safely while sitting on the chair
- Flexi back and Synchro Slide variants
- HB and MB variants provides flexibility to choose as per requirement
- Auto tip-up mechanism allows for better aisle space utilization in an auditorium, while making it easy for the user to operate
- Caps to hide grouting bolts: Which gives pleasing aesthetics
- Application Area: Can be installed in both Linear as well as Curved Layouts

**Line Diagram**

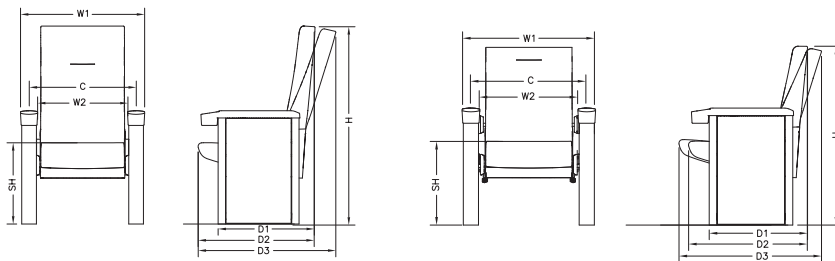

**Specification**

All sizes in CM

Model	Centre To Centre	Width (W1)	Width (W2)	Seat Height (SH)
Flexi-back (HB/MB)	58.20	67.50	48.90	44.10
	<b>Depth (D1)</b>	<b>Depth (D2)</b>	<b>Depth (D3)</b>	<b>Height (H)</b>
	52.20/51.40	63.10/62.30	77/73	107.30/95.30
Synchro Slide (HB/MB)	61	70.30	51.70	44.10
	<b>Depth (D1)</b>	<b>Depth (D2)</b>	<b>Depth (D3)</b>	<b>Height (H)</b>
	51.40/50.80	63.20/61.60	77/76.80	107.30/95.30

**Colour Swatch**



Carbon Black



Azure Blue



Ruby Red

SEATING/Auditorium Seating/ **Glamour NXT**



**Features:**

- Injection molded seat and back cover, add to contemporary styling and life of chair
- Auto tip-up mechanism allows for better aisle space utilization in an auditorium, while making it easy for the user to operate.
- Two optional PU armrests: With and without cupholder
- Application areas: Can be installed in all linear layout space plans.

**Line Diagram**

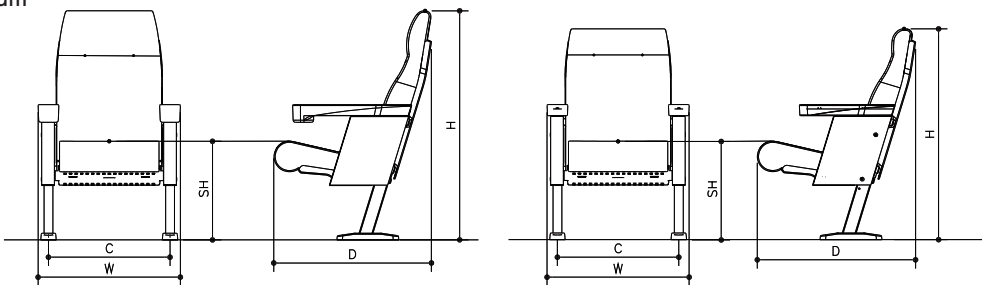

**Specification**

*All sizes in CM*

Model	length	Height	Depth	Seat Height
High Back	64	103.50	71.50	44.50
Mid Back	64	95	71.50	44.50

**Colour Swatch**



Carbon Black



Royal Blue



Milan Red



Copper Moon



**Features:**

- Grouting method makes installations neat and easy. With this method, chairs get installed and replaced conveniently, without disrupting the foundation.
- Foundation bolt cover ensures an aesthetic look
- The seat back cover provides extra support which increases the durability and hence the PLC
- Auto Seat Tip Up Feature
- PP armrests for ease and comfort

**Line Diagram**

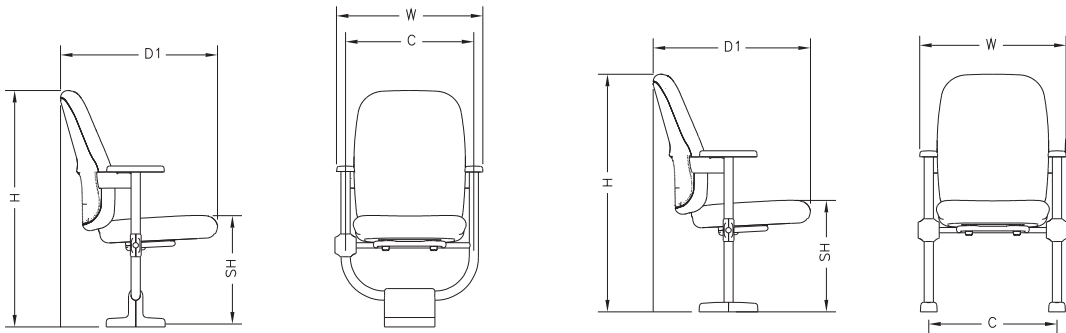

**Specification**

*All sizes in CM*

**Colour Switch**

Model	Length	Height	Depth	Seat Height
U Frame	60.90	98.40	65.40	46.20
I Frame	60.90	98.40	65.40	46.20



Royal Blue



Milan Red



Black Ink

SEATING/Auditorium Seating/ **Jupiter**



**Features:**

- Understructure fixed to ground by foundation expansion bolts for greater stability
- Armrest understructure is upholstered PU foam molded with MS insert and Arm tops are made of seasoned wood for more aesthetics and comfort
- Modern as well as highly functional and aesthetically appealing auditorium seating suitable for modern interiors of a modern auditorium.

**Line Diagram**

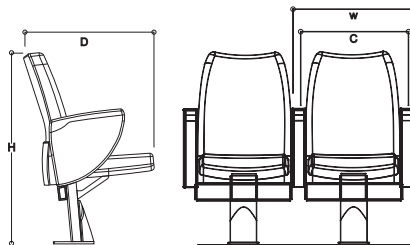

**Specification**

*All sizes in CM*

Model	Length	Depth	Height	Seat Height
High back (Individual arm)	60	64	101	46.50
High back (Common arm)	53	64	101	46.50
Mid back (Individual arm)	60	69	89	46.50
Mid back (Common arm)	53	69	89	46.50

**Colour Swatch**

FC18	FC06	FC42	FC64
FC01	FC04	FC07	FC22
FC24	FC12	FC14	FC25
FC08	FC16	FC02	FC10
FC03			



# INTERACTIVE

ACTIVE SEATING SOLUTIONS

## LOOP

- Loops's generous waterfall radius on the top edge enhances comfort. It ensures optimum clearance between the knee and the seat
- The bowl shaped bottom lets the user sway in all directions helping to adopt dynamic postures



### Specification

Model	Width	Depth	Height
Loop	45.50	45.50	51.00

### Colour Swatch

	Top Panel	Bottom Panel
FS11-Vivid Cerulean + FS72-Mink,		
FS02- Dark Tangerine + FS72-Mink,		
FS04-Denim + FS72-Mink		

## CRADLE

- Cradle's bucket-shaped seating surface top provides a large contact area for comfort and support
- Its cradle-shaped bottom aids in rocking to and fro
- The strap along the centre acts as a handle for easy mobility

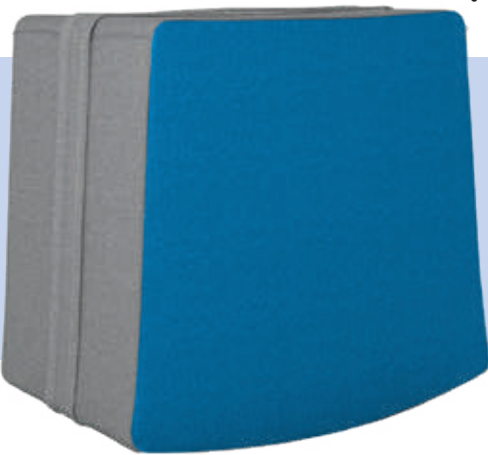

### Specification

Model	Width	Depth	Height
Cradle	56.50	33.50	51.50

### Colour Switch



FS02- Dark  
Tangerine +  
FS72-Mink,



FS20-  
Cardinal +  
FS72-Mink



FS04-Denim +  
FS72-Mink



## DRIFT

- Drift's flat top and round edge supports freedom of movement
- Its wooden base is attached with castors and can be moved around in all directions with ease



### Specification

Model	Width	Depth	Height
Drift	44.50	44.50	57.50

### Colour Swatch



FS05-  
Leaf  
Green



FS11-  
Vivid  
Cerulean



FS72-Mink

## TOGGLE

- Toggle's bulbous top has a generous waterfall radius on the top edge that ensures optimal clearance between the seat and user's knee
- Its upper and bottom halves are connected with a spring which lets the user wobble in all directions while sitting
- The base is broad at the bottom for stability, while the narrower top allows the seat to move easily in all directions



### Specification

Model	Width	Depth	Height
Toggle	52.50	52.50	52.50

### Colour Swatch



FS05-  
Leaf Green +  
FS72-Mink,



FS20-  
Cardinal +  
FS72-Mink



FS04-Denim +  
FS72-Mink

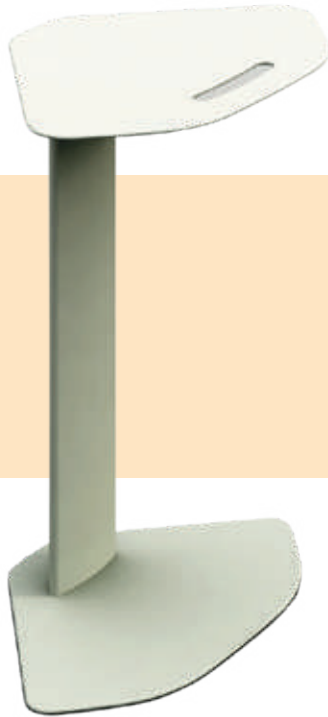

## PROP TABLE



### Specification

Model	Width	Height
Prop Table	51.40	66.20



# CUE

WORK LOUNGE

## CUE /work lounge

**Features:**

The CUE Work Lounge comprises of standalone horizontal poufs, curved poufs, sofa sets and discussion carriages. You can combine these elements in any number of combinations and layouts, creating workspaces that are perfect for your teams.



3 Seater poufs and configurations

Sofas with 700 mm panels

Units with 1200 mm panels

Units with 1400 mm panels

Meeting Booth Units with 2100 mm panels

Phone Booth Units with 2100 mm panels

**Colour Switch**

<i>Seat</i>			
	<i>FS05- Leaf Green</i>	<i>FS20- Cardinal</i>	<i>FS04- Denim</i>
<i>Panels &amp; Base</i>			
	<i>FB51- Shadow</i>	<i>FB03- Cement Gray</i>	

# Specifications



1 seater  
59 x 59 x 44.50

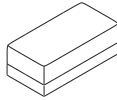

2 seater  
118 x 59 x 44.50

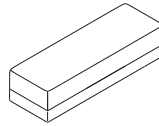

3 seater  
177 x 59 x 44.50



45 degree curved seat  
101.40 x 64 x 44.50 (seat depth: 59)

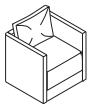

1 seater sofa 700  
70 x 65 x 70

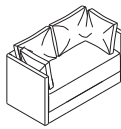

2 seater sofa 700  
129 x 65 x 70

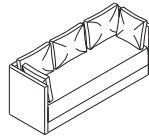

3 seater sofa 700  
188 x 65 x 70

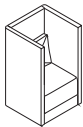

1 seater sofa 1200  
70 x 65 x 120

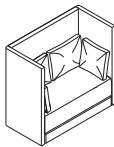

2 seater sofa 1200  
129 x 65 x 120

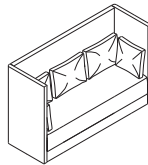

3 seater sofa 1200  
188 x 65 x 120

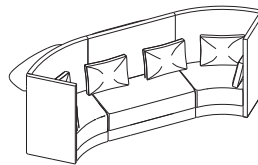

Media Cluster small  
337.5 x 126.5 x 120

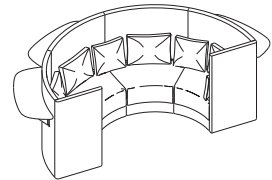

45 Circular 1200  
356.5 x 183.5 x 120

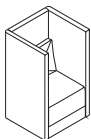

1 seater sofa 1400  
70 x 65 x 140

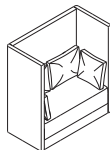

2 seater sofa 1400  
129 x 65 x 140

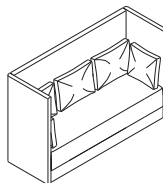

3 seater sofa 1400  
188 x 65 x 140

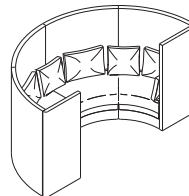

45 Circular 1400  
295 x 157 x 140

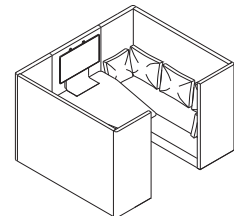

Media Booth  
188 x 218 x 140

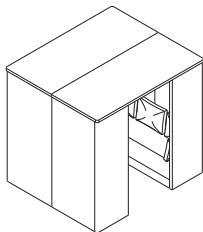

Meeting Booth  
220 x 190 x 210

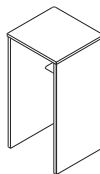

Phone Booth  
99 x 95 x 210

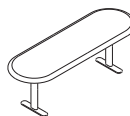

Tea table  
120 x 40 x 40

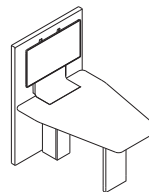

Media screen  
90 x 126 x 140

**All dimensions  
are in cm and  
follow L x W x H**



# OPOS

MOBILE SYSTEMS

OPOS/Mobile Systems/ **Habitat**

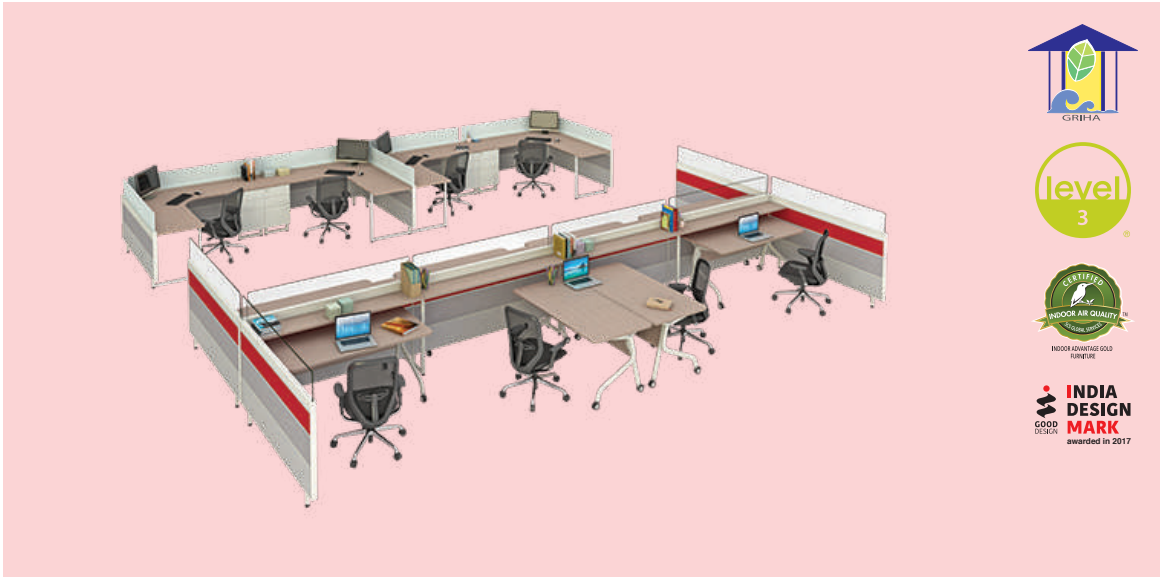

**Features:**

- Habitat is a complete offering for creating an office ecosystem with modular furniture
- It is ideal for workplace solutions where design aesthetics, functionality and sustainability is the concept
- It is designed for workspaces which are seeking Immediate Flexibility and re-configurability in the layouts, which can be done by the user instantly as per their space utility requirements
- The elements of Habitat include the WISH low height system, WALL full height, Mobile FOLD Tables, Media Unit-Mimo, ETHOS Task Light, Mobile Marker Board Screens along with mobile power posts

**Various Elements of Habitat**



Mimo (Mobile interactive media unit) (front)



Mimo (Mobile interactive media unit) (back)



Mobile marker board screen





Portable power post



Ethos Tasklight  
(floor-mounted)



Ethos Tasklight  
(desk-mounted)



Fold Table

Accessories:



Name Plate



CPU Holder

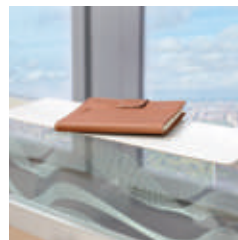

Open Shelf (single)



Open Shelf (double)



# OPOS

TILE BASED SYSTEMS

OPOS/Tile Based Systems/ **Wish**

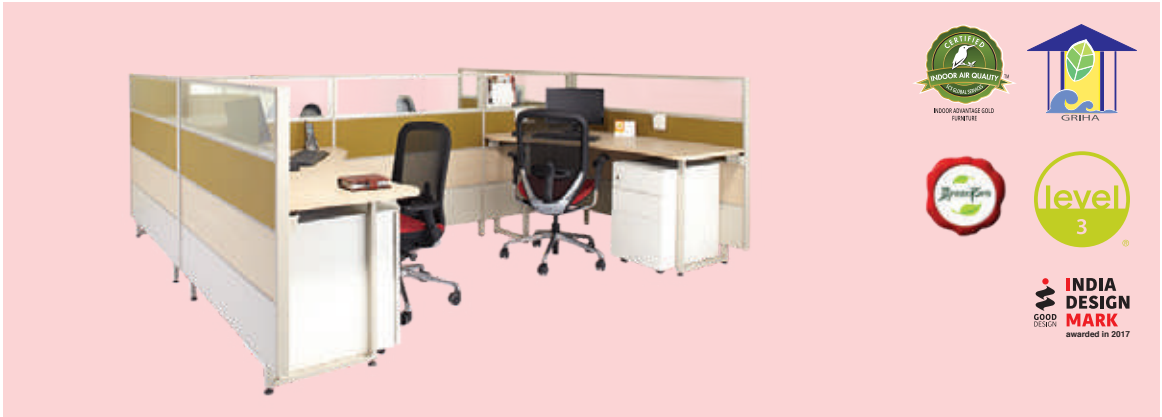

**Features:**

- Wish is a Gapless, Design-differentiated, Unique Modular workstation system incorporating the sturdiness of a panel based and the wire management capabilities of a tile based modular workstation system
- It can cater to creative layouts with flexible possibilities for workspace designs
- WISH is so versatile due to its simple design. It grants a contemporary look to the creatively designed layout
- Its horizontal band looks in the panels to the feeling of expanse the workspace
- Its design integrated accessories and storage options accentuate the aesthetics and functionality of the workstation

*Design Registered*

OPOS/Tile Based Systems/ **Xpress Office**



**Features:**

- The new Xpress Office is a quick buy option in office modular workstation furniture which offers a solution for all issues faced to execute office interiors. Xpress Office comes with the options of 4 colour schemes to choose from and with over 100 variants of configuration and size put together
- With all the upholstery and the switch mounting provision coming made in the module from the manufacturing plant itself, its only installation of the modules which will take least time to hand over the ready site to the customer
- With better delivery schedules and faster installation time, it is available in the EDP range of furnitures

OPOS/Tile Based Systems/ **Wall Full Height Partitions**



**Features:**

- Wall is a partition solution that offers you the perfect answer when you are looking to blend contemporary workspace aesthetics with the comfort of speedy execution
- It is a Gapless modular full height partition system, designed to provide the aesthetic appeal while also catering to the general functional needs of the office users
- Available in an expansive collection of tile finishes and facilitating a variety of functions, wall helps create spaces that are inspirational and enhance productivity
- It provides for writing surfaces, display shelves, provisions for display monitor mounting switch and wire management in panels



# OPOS

DESK BASED SYSTEM

OPOS/Desk Based System/ **Dfine**

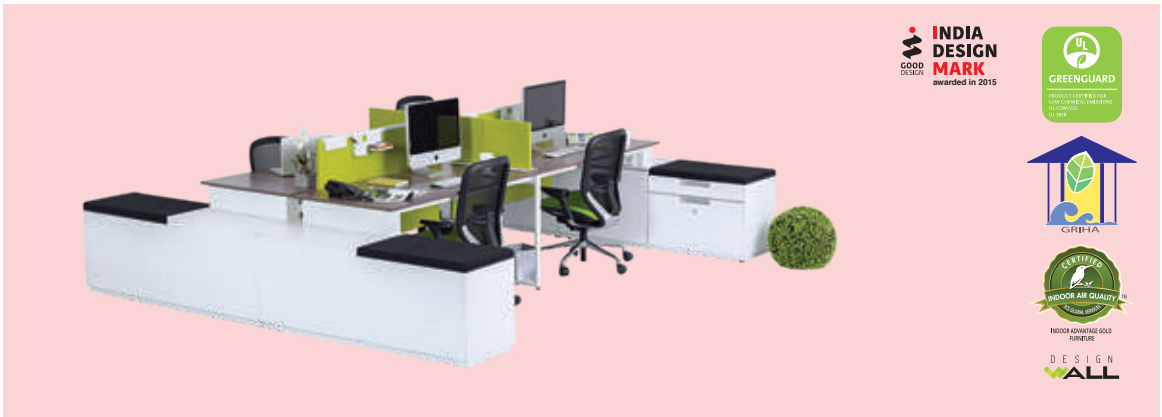

**Features:**

- Workstation configuration with sliding worktops and sliding monitor holder, enables the modules to be used for collaborative work when required and can be used as individual focused work tables when not in a meeting mode
- With the provision of the meeting pods within the workstation clusters, combined with the possibility of having marker surfaces as well as screen mounting facility
- The Credenza gives ample storage area for an individual's need of files as well as immediate stationery requirements which are inevitable in offices. Storage of CPU or laptop bags need not be thought about separately or added as an afterthought as the Credenza also takes care of these
- Different configurations for team leaders seamlessly gel in with the employee modules catering to horizontal structures, while the cabin configurations provide the private offices' needs for vertical structures

*Design Registered*

OPOS/Desk Based System/ **Reason**



**Features:**

- Reason offers benching solutions, return units, sit stand units, overhead storage units
- Reason is a global design which is Indian at heart. It combines unique understanding of Indian consumers with global looks
- The sit stand unit in reason provides the space for impromptu meeting which arise in such collaborative work profiles. It is the perfect solution for collaborative workspaces
- Neat and wire clutter-free workspace is an inherent need of any Indian workspace and with the unique solution the wire could be kept out of sight. For higher wire requirements, the cable wall provides ample solution for concealed wire management

*Design Registered*

OPOS/Desk Based System/ **Upbeat**



**Features:**

- In the age of rapidly transforming businesses, workspaces are also becoming increasingly dynamic. Today, workspace is no longer just a place where people sit and work; it is meant to serve as an extension of our ideas, personality and the way we get work done. New-age workspaces need next-gen furniture solutions that inspire optimum performance. Solutions need to be designed to fit every individual's personality.
- Upbeat is a Complete office Furniture setup solution, designed to cater to the various settings in an office space. The system offers five different Leg designs on a platform design understructure to create the identity that is required by the workspace. A range of screen finishes and looks can be mixed-n- matched to create unique spaces within the regular office layout. Different options for wire management and uniquely designed accessories add to the flexibility of the workstation offering. It also provides an exhaustive range of size and configuration which gives the flexibility to create multiple types of clusters. The configurations that could be created with upbeat are - Regular tables, High tables, mobile tables, meeting tables, conference tables









# STORAGE

AISLE AND BACK STORAGE

STORAGE/Aisle and Back Storage/ **Mobile Caddy**



**Features:**

- A complete knock-down construction with adjustable shelf, Mobile Caddy can have a TDU+RH Drawer or TDU+LH Drawer configuration as required
- It enables customized arrangements for every work situation, making it ideal for team and project work requirements
- It has lockable casters for outer body and anti-tilt caster for pedestal, ensuring flexibility and overall stability
- Maximizes storage space in user's reach with its full drawer accessibility with one box drawer having removable stationary tray

**Line Diagram**

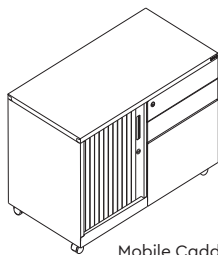

Mobile Caddy LH

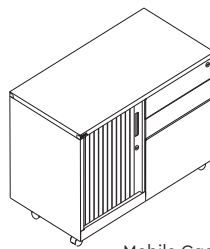

Mobile Caddy RH

**Specification**

Model	Length	Depth	Height
Caddy	105	47.20	64

All sizes in CM

**Colour Swatch**



PW27-TeX.  
Bond White



PW82-  
Prince Grey

STORAGE/Aisle and Back Storage/ **Cell Phone Lockers**



**Features:**

- Cell Phone Locker comes in variants of 30-door Wall Mounting and 60-door Wall Mounting/Standalone (with aluminum base)
- Options • It is available in a fully assembled construction in Bond White and Prince Grey, with 180 degree door-opening for more convenience
- They are ideal when wall spaces are limited and can be used to store cell phone, wallets and other valuables carried for day-to-day use to schools, health clubs and work

**Line Diagram**

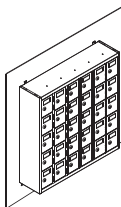

30 Door  
Cellphone Locker  
Wall Mounting

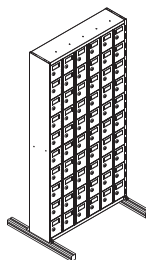

60 Door  
Cellphone Locker  
With Stand

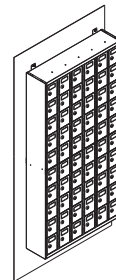

60 Door  
Cellphone Locker  
Wall Mounting

**Specification**

*All sizes in CM*

Model	Length	Depth	Height
30 Door Locker	90	22.50	93.30
60 Door Locker Wall Mounted	90	22.50	180
60 Door Locker Stand Fixed	94.50	56	184.50

**Colour Swatch**



PW27-*Tex.*  
Bond White



PW82-*Prince*  
Prince Grey

STORAGE/Aisle and Back Storage/ **Reserve**



**Features:**

- Individual Units - can be used as aisle side storages and back units • LH and RH Units - For seamless integration of multiple units and to give the combined configuration an elegant • Shared Units - Used in between end units are required to create optimum storage spaces • Available with legs as well as skirting for seamless integration with workstation

**Line Diagram**

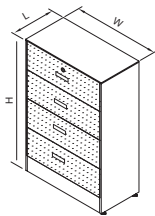

LFC with Skirting

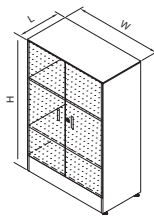

HDU with Skirting

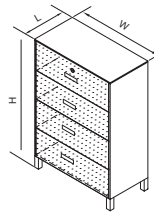

LFC with Legs

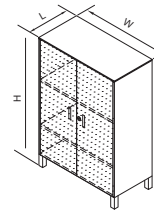

HDU with Legs

**Specification**

*All sizes in CM*

Model	Length	Depth	Height
LFC with Skirting	75/80/90/95/100/105	46	75/119/134.3
HDU with Skirting	45/60/65/75/80/90/95/100/105/120	46	75/119/134.3
LFC with Legs	75/80/90/95/100/105	46	75/120/135.30
HDU with Legs	45/60/65/75/80/90/95/100/105/120	46	75/120/135.30

**Colour Swatch**



*Metal Body:  
PW27-*Tex. Bond White +  
Wooden Shutter:  
LM104-Kitami Elm**

STORAGE/Aisle and Back Storage/ **Echo**



**Features:**

- Available in two range of 1) SDUs and 2) HDUs • All wood range product with intelligent optimization of the boards in effective price range • Simple geometry and construction detailing for easy transportation in smaller compact packs and assembly • Light and specious look to interiors with white laminate used for shelves, divider panels and back panel

**Line Diagram**

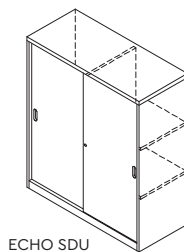

ECHO SDU

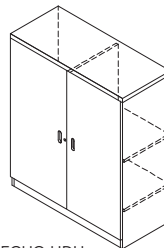

ECHO HDU

**Specification**

All sizes in CM

**ECHO SDU SIZES**

Height	Width	Depth
695	750	450
695	900	450
695	1050	450
695	1200	450
1066	750	450
1066	900	450
1066	1050	450
1066	1200	450
1219	750	450
1219	900	450
1219	1050	450
1219	1200	450

**ECHO HDU SIZES**

Height	Width	Depth
695	450	450
695	750	450
695	900	450
695	1050	450
1066	450	450
1066	750	450
1066	900	450
1066	1050	450
1219	450	450
1219	750	450
1219	900	450
1219	1050	450

**Colour Swatch**



Metal Body:  
PW27-*Tex. Bond White* +  
Wooden Shutter:  
LM104-*Kitami Elm*

STORAGE/Aisle and Back Storage/ **Tambour Door Unit**



**Features:**

- Doors roll inwards preventing blockage of space while in use
- Translucent double shutters provide aesthetic appeal
- Central locking for safety
- A wide range of accessories for different usage needs

**Line Diagram**

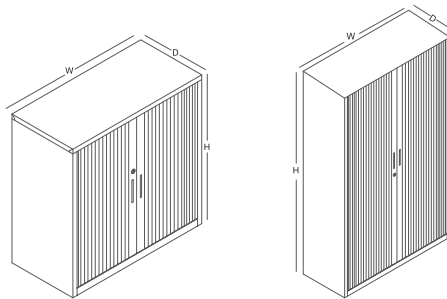

**Specification**

*All sizes in CM*

Model	Length	Depth	Height
TDU	75	47	69
	75	47	116.90
	90	47	69
	90	47	116.90
	90	47	200
	120	47	69
	120	47	116.90
	120	47	200

**Colour Swatch**



PW27-*Tex.*  
Bond White

STORAGE/Aisle and Back Storage/ **Cushion LFC and Pedestal**



**Features:**

- Smooth drawer movement with **precision telescopic slider mechanism**
- An **anti-rebound mechanism** to prevent the drawer from coming out after it is pushed in
- An **anti-tipping mechanism** that allows only one drawer to be opened at a time to prevent toppling over of the cabinet
- Option of wooden and metal top
- Available in 2, 3 and 4 drawer options
- LFC also available with cushions which can double up as additional seating
- 100% VOC free powder coating

**Line Diagram**

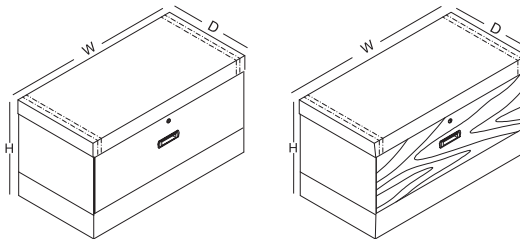

**Specification**

All sizes in CM

Model	Length	Depth	Height
Metal & Wooden	75.50	45.50	50.20
Front	90.50	45.50	50.20
	105.50	45.50	50.20

**Colour Swatch**



PW27  
Tex. Bond White  
+ LM27  
Frosty White



PW27  
Tex. Bond White  
+ LM104  
Kitami Elm

STORAGE/Aisle and Back Storage/**Vertical Filing Cabinet**



**Features:**

- Smooth drawer movement with **precision telescopic slider mechanism**
- An **anti-rebound mechanism** to prevent the drawer from coming out after it is pushed in
- An **anti-tipping mechanism** that allows only one drawer to be opened at a time to prevent toppling over of the cabinet

**Line Diagram**

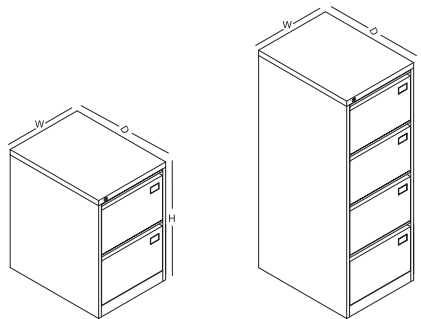

**Specification**

*All sizes in CM*

Model	Length	Depth	Height
2 Drawer VFC	47	62	71
4 Drawer VFC	47	62	132

**Colour Swatch**



PW82  
Prince  
Grey



PW09  
Cloud  
Grey



PW27  
Tex. Bond  
White



# STORAGE/Aisle and Back Storage/ Lateral Filing Cabinet



## Features:

- These are ideally suitable for aisle space. It comes with **anti-tipping & anti-rebound mechanism** to ensure safety of user
- Options of 2 & 4 drawers & availability in different sizes provide ample choice as per requirement
- Minimalistic & sturdy, it enables easy access to all content/files at one go
- Ease in identification of files with more storage

## Line Diagram

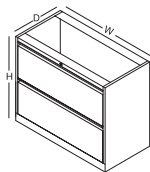

2 Drawer LFC

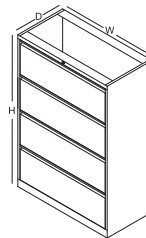

4 Drawer LFC

## Specification

All sizes in CM

Model	Length	Depth	Height
2 Drawer LFC (with Laminate Top)	90	45	712.50
4 Drawer LFC (with Laminate Top)	90	45	1322.50
2 Drawer LFC (with Metal Top)	90	45	712.50
4 Drawer LFC (with Metal Top)	90	45	1322.50

All sizes in CM

## Colour Switch



Body and Top-PW82  
Prince Grey



Body and Top-PW09  
Cloud Grey



Body- PW27-*Tex.*  
Bond White  
Top- LM104-Kitami Elm



Body- PW82-  
Prince Grey  
Top- LM110-  
Greystone Light



Body- PW09-  
Cloud Grey  
Top- LM09-  
Cloud Grey



Body and Top PW27-*Tex.*  
Bond White



Body & Top-  
PW78-  
Medieval Town

# STORAGE/Aisle and Back Storage/ **Sliding Door Unit**



### Features:

- Sliding door construction saves aisle space - ships knocked down
- Storage flexibility achieved through use of adjustable shelves
- Aesthetically appealing snap-on die-cast lock for security
- Plastic roller with steel ball bearings for smoother door movement
- Option of wooden and metal top for low height units

### Line Diagram

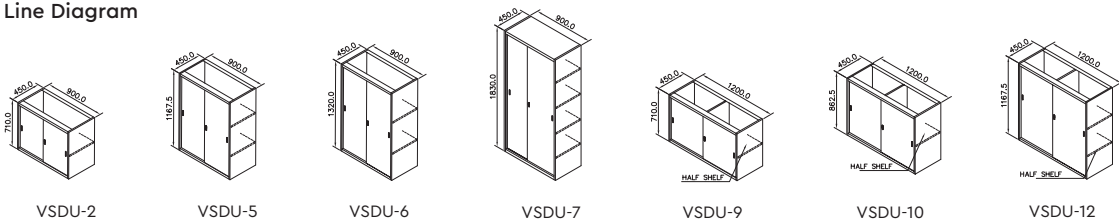

### Specification

All sizes in CM

Model	Length	Depth	Height
VSDU With Metal Top 2	90	45	71
VSDU With Metal Top 5	90	45	1167.50
VSDU With Metal Top 6	90	45	132
VSDU With Metal Top 7	90	45	183
VSDU With Metal Top 9	120	45	71
VSDU With Metal Top 10	120	45	862.50
VSDU With Metal Top 12	120	45	1167.50
VSDU With Laminate Top 2	90	45	73.50
VSDU With Laminate Top 5	90	45	1192.50
VSDU With Laminate Top 6	90	45	134.50
VSDU With Laminate Top 9	120	45	73.50
VSDU With Laminate Top 10	120	45	887.50
VSDU With Laminate Top 12	120	45	1192.50

### Colour Swatch

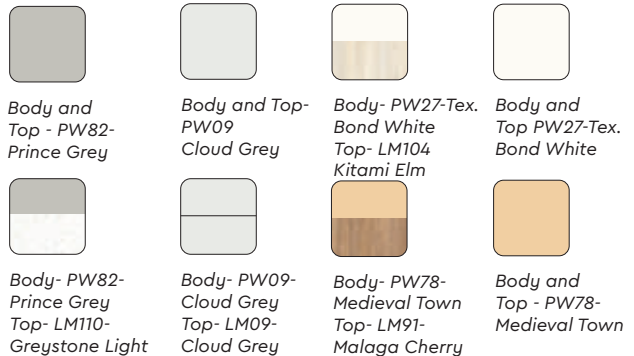

Body and Top - PW82-Prince Grey

Body- PW82-Prince Grey  
Top- LM110-Greystone Light

Body and Top- PW09-Cloud Grey

Body- PW09-Cloud Grey  
Top- LM09-Cloud Grey

Body- PW27-TEX. Bond White  
Top- LM104-Kitami Elm

Body- PW78-Medieval Town  
Top- LM91-Malaga Cherry

Body and Top PW27-TEX. Bond White

Body and Top - PW78-Medieval Town

STORAGE/Aisle and Back Storage/ **Store Up**



**Features:**

- **OPTIMIZED STORAGE SPACE:** This aesthetically appealing, hassle-free and ergonomically designed storage unit makes optimum utilization of your office storage space and exploits your space's true potential
- **CORNER STORAGE:** Store Up utilizes the corner spaces in your office which doubles your existing storage space and enables optimum utilization of your office's storage space
- **ENDLESS CONFIGURATION :** Store Up can be installed in an unending line up with no limit to the number of main plus add on bodies
- **STURDY UNIT:** Store Up is made of a sturdy metal carcass structure

**Line Diagram**

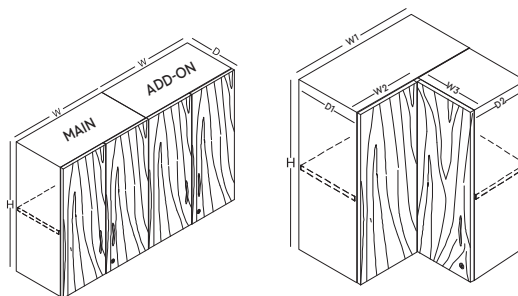

**Specification**

All sizes in CM

Model	Length	Depth	Height
Store Up	30	32.60	78.50
	45	32.60	78.50
	60	32.60	78.50
	80	32.60	78.50
	90	32.60	78.50
W1	60	32.60	78.50
W2	31	-	-
W3	30	-	-

**Colour Swatch**



Body- PW27-*Tex.*  
Bond White  
Top- LM104-*Kitami Elm*



Body- PW78-*Medieval Town*  
Top- LM91-*Malaga Cherry*



# STORAGE

DISPLAY STORAGE

# STORAGE/Display Storage/ **Periodical Display Rack (PDR)**



**Features:**

- Available in Main and Add-on Units with 5 Compartments per Unit. Each compartment is provided with a pivoted inclined retractable tray for display purpose. The compartment behind the tray can be used for storing
- The units are made from prime quality CRCA Steel with Anti-Rust Treatment and PLB Side Panels for stylish appearance and long life.

**Line Diagram**

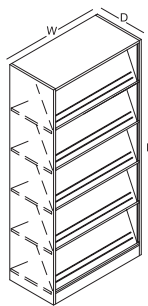

All Steel PDR

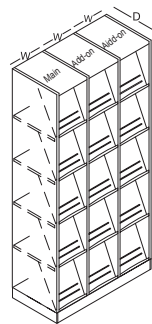

Wood & Steel PDR

**Specification**

All sizes in CM

Model	Length	Depth	Height
All Steel PDR	90	45	183
Wood and Steel PDR	28.80 / 31.30	40	189

**Colour Swatch**



PW09-  
Cloud Grey



PW27-  
Tex. Bond White

STORAGE/Display Storage/ **Sliding Glass Door Unit**



**Features:**

- Sliding door construction saves aisle space - ships knocked down
- Storage flexibility achieved through use of adjustable shelves
- Aesthetically appealing snap-on die-cast lock for security
- Plastic roller with steel ball bearings for smoother door movement

**Line Diagram**

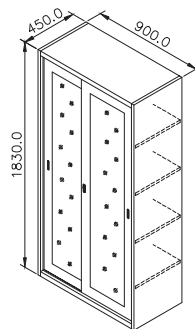

VSDU-8

**Specification**

**Model**  
VSDU with Metal top

*All sizes in CM*

Length	Depth	Height
90	45	183

**Colour Swatch**



Body and Top - PW82- Prince Grey



Body and Top-PW09 Cloud Grey



Body- PW82- Prince Grey Top-LM110 Greystone Light



Body- PW09- Cloud Grey Top- LM09- Cloud Grey



Body - PW27- Tex. Bond White Top - LM104- Kitami Elm



Body- PW78- Medieval Town Top- LM91- Malaga Cherry



Body and Top - PW27- Tex. Bond White



Body and Top - PW78- Medieval Town



# STORAGE

PERSONAL STORAGE

STORAGE/Personal Storage/**Nova**



**Features:**

- An efficient personal storage solution to banish clutter from your work desks
- Available in free standing & top supporting options
- Enhanced with an anti-rebound mechanism to prevent any kind of damages

**Line Diagram**

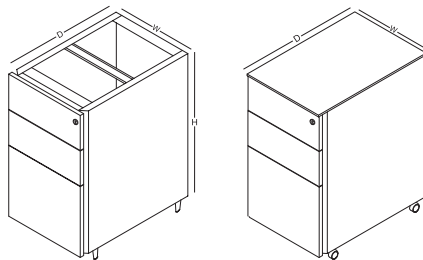

**Specification**

*All sizes in CM*

Model	Length	Depth	Height
Free standing BBF Pedestal	39	59	64.60
Top Supporting BBF Pedestal	39	43.50	67.40
Free standing BBF Pedestal	39	44	64.60

**Colour Switch**



PW09-  
Cloud Grey



PW01-  
Black Ink



STORAGE/Personal Storage/ **Wooden PLU**



**Features:**

- Wooden lockers are specially designed for open plan offices which can be used anywhere in office workspace.
- The Lockers collection offers diverse locking systems, from traditional key locking systems to more advanced keyless solutions for easy access to user with high security.
- Lockers are designed to suit any aesthetics with choice of customer in office workspace.
- It has provision of personalized document slot with name plate.

**Line Diagram**

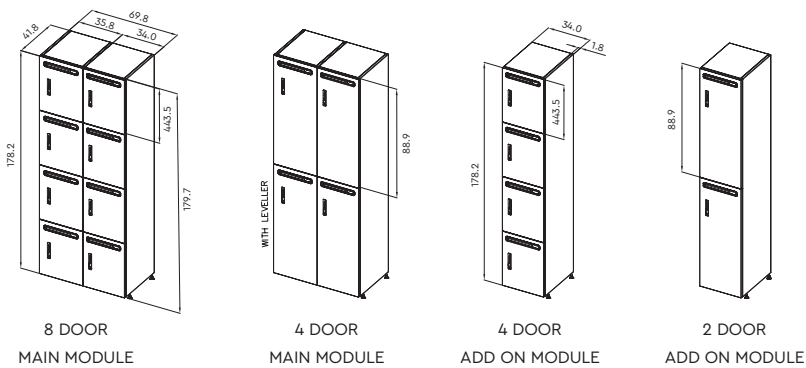

**Specification**

All sizes in CM

Model	Length	Depth	Height
Main unit	69.80	41.80	180
Addon Unit	34	41.80	180

**Colour Swatch**

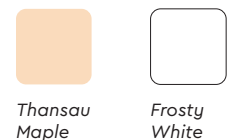

# STORAGE/Personal Storage/**Personal Locker Unit**



**Features:**

- Hanging rods in 1 & 2 Door Locker Models
- Stands are also available in option of 1 Locker, 2 Locker or 3 Locker combination and make cleaning of work area easy
- Label holders are provided for easy identification
- Lockers can be provided with or without lock and can function as stand alone units or as a multi-unit configuration
- Available locker options : Hasp, Cam, Numeric and Digital

**Line Diagram**

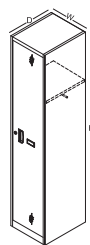

1 Door PLU

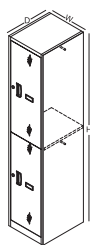

2 Door PLU

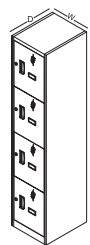

4 Door PLU



6 Door PLU

**Specification**

*All sizes in CM*

Model	Length	Depth	Height
1,2,4,6 Door PLU (Main - Add on)	38	45	183
Stand for 1 Locker	38	45	12.50
Stand for 2 Locker	76	45	12.50
Stand for 3 Locker	114	45	12.50

**Colour Swatch**



PW27-  
Tex. Bond White



# STORAGE

CONVENTIONAL STORAGE

STORAGE/Conventional Storage/ **KD Plain**



**Features:**

- Saving unit that provides safe and convenient storage of books, admin files, stationery etc.
- Provides maximum storage with 4 adjustable shelves that can store just about anything
- 3 way bolting device for safety
- Available in knock-down construction

**Line Diagram**

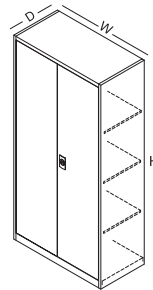

**Specification**

*All sizes in CM*

Model	Length	Depth	Height
KD Plain	90	45	183

**Colour Swatch**



PW82- Prince Grey



PW09- Cloud Grey



PW27- Tex. Bond White



PW78- Medieval Town

STORAGE/Conventional Storage/ **KD Minor**



**Features:**

- Saving unit that provides safe and convenient storage of books, admin files, stationery etc.
- Provides maximum storage with 2 adjustable shelves that can store just about anything
- 3 way bolting device and 6 lever lock for safety
- Available in welded construction

**Line Diagram**

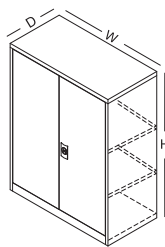

KD Minor  
(Metal Top)

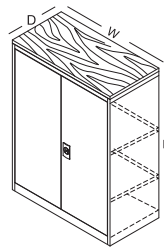

KD Minor  
(Laminate Top)

**Specification**

Model	Length	Depth	Height
KD Minor with Metal Top	90	45	1168.50
KD Minor with Laminate Top	90	45	1192.50

All sizes in CM

**Colour Swatch**



PW82-  
Prince Grey



PW09-  
Cloud Grey



PW27-  
Tex. Bond  
White



PW78-  
Medieval  
Town



# STORAGE

HIGH DENSITY STORAGE

# STORAGE/High Density Storage/ **Tile Optimizer**



**Features:**

- Designed for long life and easy part replacement
- Uses one common aisle space that optimizes available space
- Channel stoppers prevent derailment
- Label holders with neat transparent acrylic sheets facilitate easy identification
- Locking stiffeners for centralised locking ensures safety of documents
- Rotating lock with easy to identify lock/unlock position ensures safety
- Shims provided below the rails for right levelling
- Available for KD type, 1980 height with 15 & 18 inch depth type

**Line Diagram**

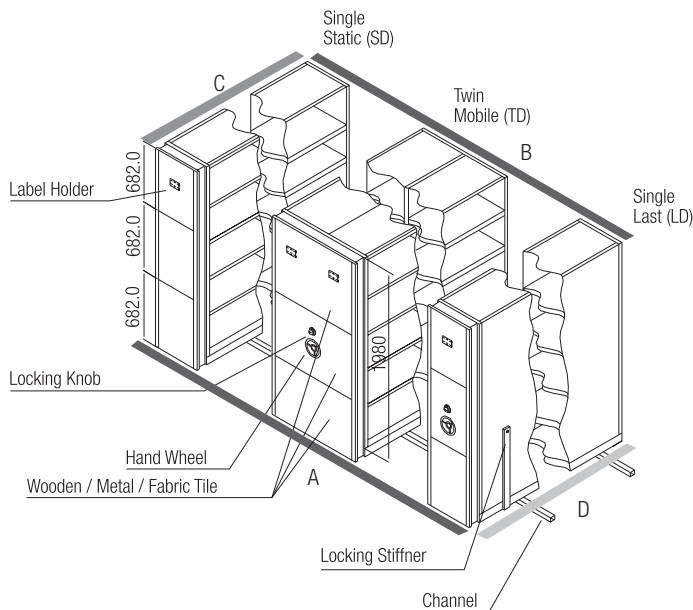

# STORAGE/High Density Storage/ Metal Optimizer



## Features:

- Designed for long life and easy part replacement
- Uses one common aisle space that optimizes available space
- PU Drive wheel for firm grip and hassle-free mobility
- Channel stoppers prevent derailment
- Label holders with neat transparent acrylic sheets facilitate easy identification
- Locking stiffeners for centralised locking ensures safety of documents
- Rotating lock with easy to identify lock/unlock position ensures safety
- Shims provided below the rails for right levelling
- Available in Drive type and Push-pull type models
- Specialised healthcare accessories available
- 100% VOC free powder coating
- Designed for long life
- 98% recyclable

## Line Diagram

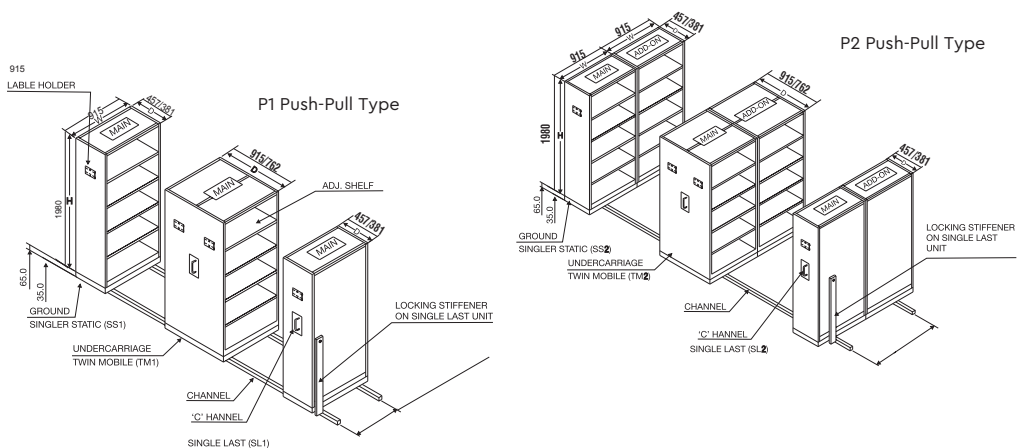



# STORAGE/High Density Storage/ Metal Optimizer

## Line Diagram

D2 DriveType

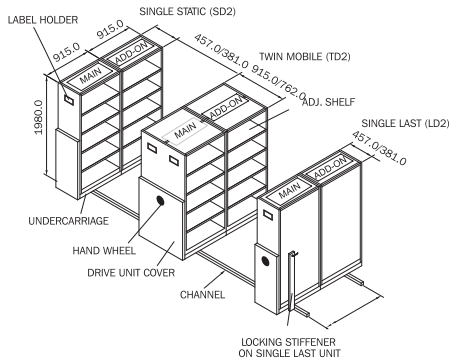

D3 DriveType

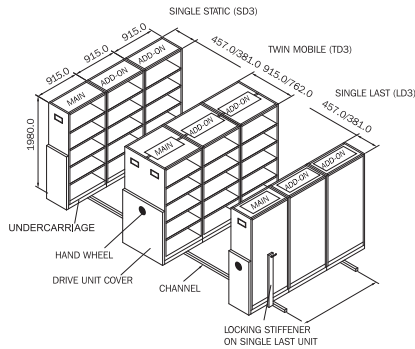

D4 DriveType

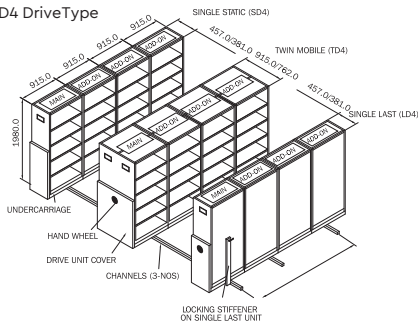

D5 DriveType

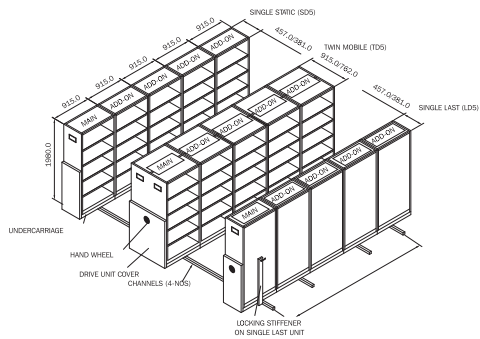

Body, understructure  
& Looking Stiffner



PW27-Tex.  
Bond White +  
PW78-  
Medieval Town



PW09-  
Cloud Grey +  
PW82-  
Prince Grey

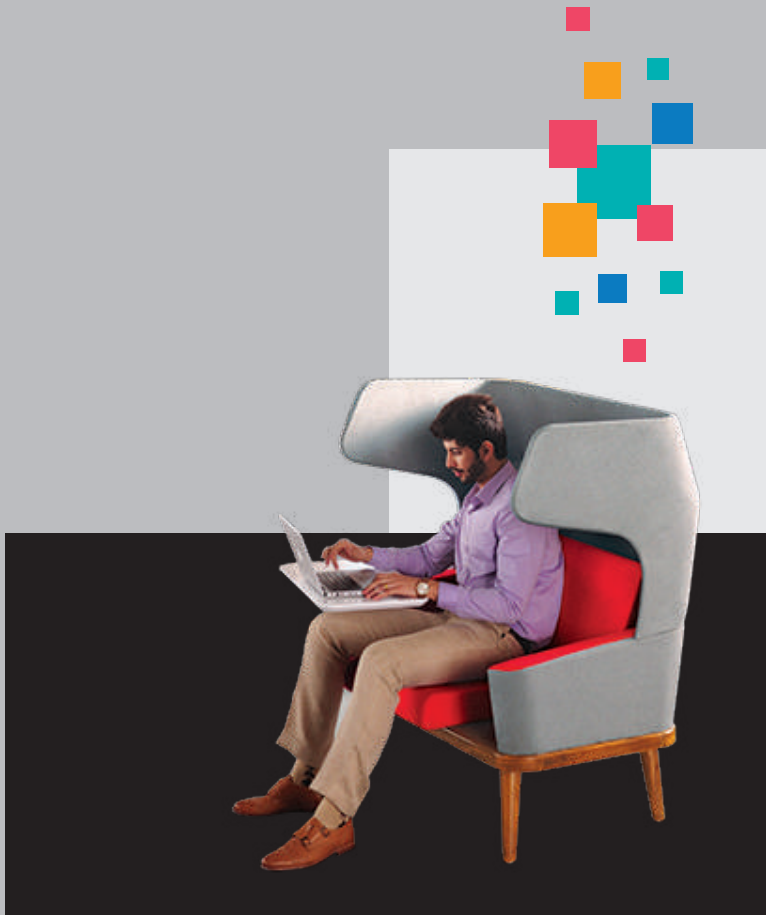

# SOCIAL

OFFICE

## Immerse Work Pod

### Specification

122.50 X 93.50 X 132.80

### Colour Swatch



FS05-  
Leaf Green +  
FS72-Mink



FS20-  
Cardinal +  
FS72-Mink



FS02- Dark  
Tangerine +  
FS72-Mink



FS11-Vivid  
Cerulean +  
FS72-Mink



FS04-Denim +  
FS72-Mink



## Assert Table



### Specification

135 X 135 X 75

### Colour Swatch



White +  
solid wood

# Assert Bench

## Specification

120 X 45 X 47

## Colour Swatch



LS05-  
Leaf  
Green



LS20-  
Cardinal



LS02-  
Dark  
Tangerine



LS11-  
Vivid  
Cerulean



LS74-  
Horizon



LS48-  
Slate Grey



# Vivid Chair



## Specification

43.50 X 56.50 X 87.50

## Colour Swatch



LS05-  
Leaf Green +  
PW05  
Leaf Green +



LS20-  
Cardinal +  
PW20-Cardinal



LS02-  
Dark Tangerine +  
PW02-  
Dark Tangerine



LS11-Vivid  
Cerulean +  
PW11-Vivid  
Cerulean



LS74-  
Horizon +  
PW74-  
Horizon



LS48-  
Slate Grey +  
PW48-  
Slate Grey

## Omega Planter

Specification

DIA 100 X 76.30

Colour Swatch



White



## Omega Bench



Specification

100 X 100 X 45

Colour Swatch



Solid  
Wood

## Topo Square

### Specification

90 X 90 X 72  
 Topo Hi Square  
 90 X 90 X 102

### Colour Switch



PW05-  
Leaf  
Green



PW20-  
Cardinal



PW02-  
Dark  
Tangerine



PW11-  
Vivid  
Cerulean



PW74-  
Horizon



PW48-  
Slate Grey



## Topo Circle



### Specification

DIA 90 X 70  
 Topo Hi Circle  
 DIA 90 X 102

### Colour Switch



PW05-  
Leaf  
Green



PW20-  
Cardinal



PW02-  
Dark  
Tangerine



PW11-  
Vivid  
Cerulean



PW74-  
Horizon



PW48-  
Slate Grey

# Topo Hi Bite

## Specification

90 X 83.20 X 102

Topo Bite

90 X 83.20 X 72



## Colour Switch



PW05-  
Leaf  
Green



PW20-  
Cardinal



PW02-  
Dark  
Tangerine



PW11-  
Vivid  
Cerulean



PW74-  
Horizon



PW48-  
Slate Grey



# Topo Facet



## Specification

90 X 90 X 71.20

Topo Hi Facet

90 X 90 X 102

## Colour Switch



PW05-  
Leaf  
Green



PW20-  
Cardinal



PW02-  
Dark  
Tangerine



PW11-  
Vivid  
Cerulean



PW74-  
Horizon



PW48-  
Slate Grey

# Topo Recta

## Specification

90 X 120 X 72

## Colour Swatch



PW05-  
Leaf  
Green



PW20-  
Cardinal



PW02-  
Dark  
Tangerine



PW11-  
Vivid  
Cerulean



PW74-  
Horizon



PW48-  
Slate Grey



# Modesk



## Specification

60 X 45 X 72

## Colour Swatch



White



## Tetris-Fixed Version

### Specification

45 X 45 X 45.30

### Colour Switch



LS05-  
Leaf  
Green



LS20-  
Cardinal



LS02-  
Dark  
Tangerine



LS11-  
Vivid  
Cerulean



LS74-  
Horizon



LS48-  
Slate  
Grey



## Graph Back 2 Back Sofa



### Specification

90/120/150/180  
X 133.50 X 79

### Colour Switch



FS20-  
Cardinal +  
FS72-Mink,



FS05-  
Leaf Green +  
FS72-Mink

# Greet Chair

## Specification

63.50 X 63 X 80



## Colour Switch



LS05-  
Leaf  
Green



LS20-  
Cardinal



LS02-  
Dark  
Tangerine



LS11-  
Vivid  
Cerulean



LS74-  
Horizon



LS48-  
Slate  
Grey



# ORB



## Specification

125 X 111 X 88.50

## Colour Switch



LS05-  
Leaf Green +  
Grey Net



LS20-  
Cardinal +  
Grey Net



LS02- Dark  
Tangerine +  
Grey Net



LS11- Vivid  
Cerulean +  
Grey Net

# Graph Sofa

**Specification**

90/120/150/180  
X 70.50 X 79

**Colour Swatch**



FS20-  
Cardinal +  
FS72-Mink



FS05-  
Leaf Green +  
FS72-Mink



# Tetris-Flip Version



**Specification**

45 X 45 X 45.30

**Colour Swatch**



LS05-  
Leaf  
Green



LS20-  
Cardinal



LS02-  
Dark  
Tangerine



LS11-  
Vivid  
Cerulean



LS74-  
Horizon



LS48-  
Slate  
Grey

# Graph Bench

## Specification

50/90/120/150/180/  
X 47.10 X 44

## Colour Swatch



FS20-  
Cardinal



FS72-Mink



FS05-  
Leaf  
Green

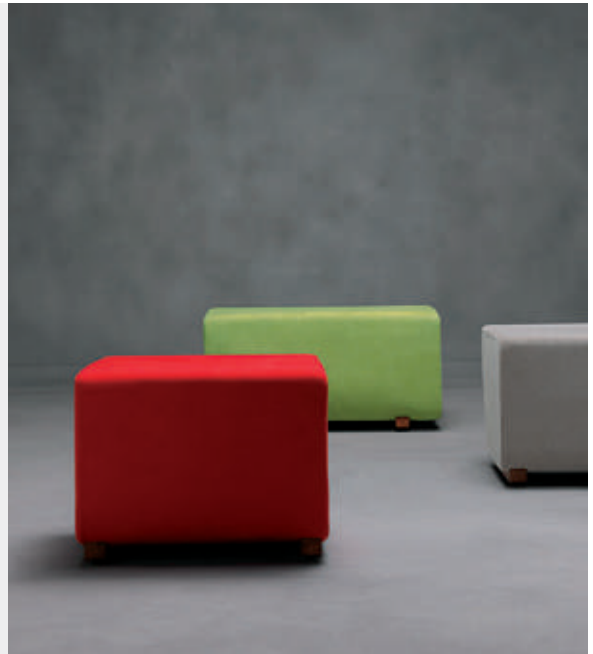

# Radix Hi-Stool



## Specification

48.60 x 47 x 73.90

## Colour Swatch



LS05-  
Leaf  
Green



LS20-  
Cardinal



LS02-  
Dark  
Tangerine



LS11-  
Vivid  
Cerulean



LS74-  
Horizon



LS48-  
Slate  
Grey

## ORBB Poufee

### Specification

Dia 76 X 30

### Colour Switch



LS05-  
Leaf Green +  
Grey Net



LS20-  
Cardinal +  
Grey Net



LS02- Dark  
Tangerine +  
Grey Net



LS11- Vivid  
Cerulean +  
Grey Net



## Clarity Lamp



### Specification

Dia 74 X 37.50

### Colour Switch



PW20-  
Cardinal



PW02-  
Dark  
Tangerine

# Tetra Single Triangular Lamp

## Specification

37 X 32

Tetra Dual Triangular Lamp

37 X 32

## Colour Swatch



PW20-  
Cardinal



PW02-  
Dark  
Tangerine



PW11-  
Vivid  
Cerulean



PW74-  
Horizon



PW48-  
Slate  
Grey

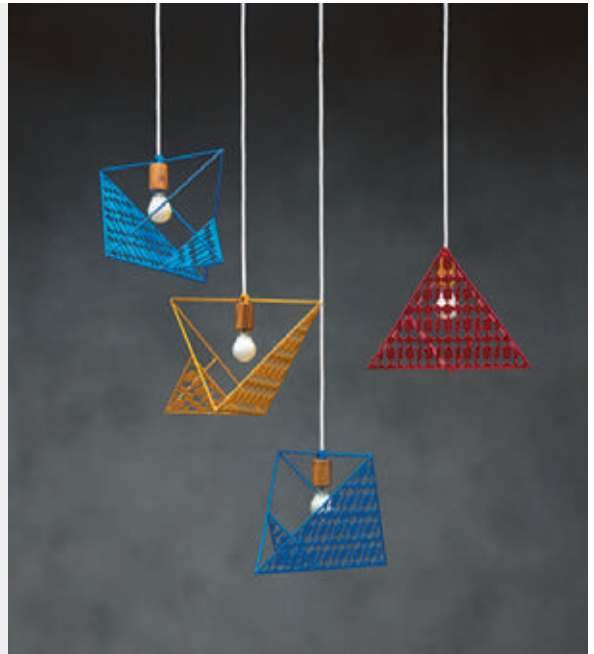

# Notebook Screen



## Specification

82 X 37 X 149.50

## Colour Swatch



FS72-Mink

# Neo Book Shelf

## Specification

99.10 X 99.10 X 32.10

## Colour Switch



05-  
Leaf  
Green



20-  
Cardinal



02-  
Dark  
Tangerine



11-  
Vivid  
Cerulean



74-  
Horizon



48-  
Slate Grey

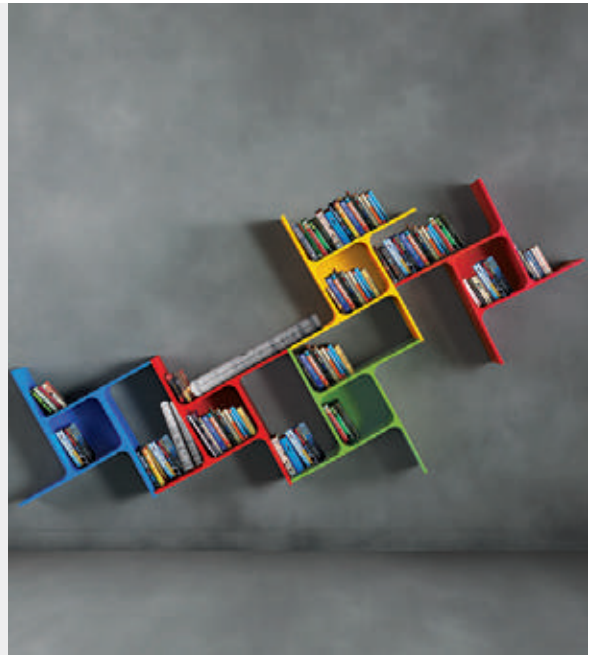



# COLOUR

SWATCH



**CREPE FABRIC SEATING (FC) – Voila**



FC03-  
Cement  
Grey



FC24-  
Blue  
Iceberg



FC12-  
Azure



FC07-  
Royal  
Blue



FC04-  
Prussian  
Blue



FC14-  
Vitamin  
Bright



FC64-  
Mint Ice



FC25-  
Country  
Green



FC08-  
Saddle  
Brown



FC16-  
Sunset  
Sky



FC18-  
Milan  
Red



FC06-  
Garnet



FC42-  
Copper  
Moon



FC22-  
Orchid  
Purple



FC01-  
Black Ink



FC02-  
Dark  
Tangerine



FC10-  
Earth  
Stone

**KNITTED FABRIC SEATING (FK)**



FK61-  
Retro Blue



FK07-  
Royal Blue



FK04-  
Prussian  
Blue



FK02-  
Dark  
Tangerine



FK08-  
Saddle  
Brown



FK 18  
Milan Red



FK 03  
Cement  
Grey



FK10-  
Earth  
Stone



FK01-  
Black  
Ink

**FOAM LAMINATED FABRIC SEATING (FL)**



FL 07-  
Royal Blue



FL 06-  
Garnet



FL 01-  
Black Ink



FL 08-  
Saddle  
Brown



FL 10  
Earth  
Stone



FL 56-  
Amethyst  
Regale



FL 04-  
Prussian  
Blue



FL 14-  
Vitamin  
Bright

**BREAKOUT & SOFA FABRIC SEATING (FB), (FS)**



FS 05  
Leaf  
Green



FS 20  
Cardinal



FS 02  
Drak  
Tangerine



FS 11  
Vivid  
Cerulean



FS 04-  
Denim



FS 72-  
Mink



FB 18-  
Milan Red



FB 04-  
Ink



FB51-  
Shadow



FB 03-  
Cement  
Grey

**PLUSH FABRIC (FP)**



FP 04-  
Dark Blue



FP 03-  
Dark Grey



FP 01-  
Chocolate

**LEATHER & LEATHERETTE SEATING (LT, LC & LS)**

**LEATHER (LT)**



LT 80-  
Natural



LT 50-  
Camel



LT 01-  
Black Ink



LT 52-  
Dark Tan



LT 53-  
Brown

**Leatherette  
Sofa (LS)**



LS 05-  
Leaf  
Green



LS 20-  
Cardinal



LS 02-  
dark  
Targierine



LS 11-  
Vivid  
Cerulean



LS 74-  
Horizon



LS 48-  
Slate  
Grey



LS 50-  
Camel



LS 52-  
Dark  
tan



LS 01  
Black  
Ink

**Leatherette  
Chair (LC)**



LC 50-  
Camel



LC 52-  
Dark Tan



LC 01-  
Black Ink



LC 53-  
Brown

**NET / MICRO / SPACER MESH FABRIC SEATING (NM & SF)**



NM 01-  
Black  
Micormesh



NM117-  
Cheshnut



NM 118-  
Charcoal



NM-  
Black  
Fabric Net



NM-  
Black  
Checked



NM-  
grey  
Checked



SF 51-  
Shadow



NM-  
Black  
Wave

**ZIP & PULLERS SEATING**



ZP05-  
Leaf  
Green



ZP20-  
Cardinal



ZP02-  
Dark  
Tangerine



ZP11-  
Vivid  
Cerulean



ZP74-  
Horizon



ZP48-  
Slate  
Grey



ZP72-  
Mink

**THREAD COLORS SEATING(TP & TN)**



TP 03-  
Cement  
Grey



TP 30-  
Blue  
Iceberg



TP 12-  
Azure



TP 07-  
Royal  
Blue



TP 04-  
Prussian  
Blue



TP 14-  
Vitamin  
Bright



TP 64-  
Mint Ice



TP 25-  
Country  
Green



TP 08-  
Saddle  
Brown



TP 16-  
Sunset  
Sky



TP 18-  
Milan  
Red



TP 06-  
Garnet



TP 42-  
Copper  
Moon



TP 22-  
Orchid  
Purple



TP 01-  
Black Ink



TP 10-  
Earth  
Stone



TP 53-  
Brown



TP 52-  
Dark  
Tan



TP 50-  
Camel



TP 05-  
Leaf  
Green



TP 20-  
Cardinal



TP 02-  
Dark  
Tangerine



TP 11-  
Vivid  
Cerulean



TP 74-  
Horizon



TP 48-  
Slat  
Grey



TP 51-  
Shadow



TP 72-  
Mink



TN 01-  
Black  
Ink



TN 52-  
Dark  
Tan



TN 50-  
Camel



TN 80-  
Natural



TN 53-  
Brown

**PLASTICS (PL)**



PL21-  
Sugar  
White



PL01-  
Black



PL26-  
Pebble  
Stone



PL05-  
GREEN



PL02-  
Yellow



PL12-  
BLUE



PL19-  
RED



PL17-  
ORANGE



PL119-  
Grey 1



PL120-  
Grey 2



PL121-  
Grey 3



PL89-  
Choco



PL122-  
Grey 4



PL123-  
Clear  
White



PL124-  
Clear Grey



PL01-  
Black  
Leveller



PL09-  
Cloud  
Grey

**UNWIND RANGE**



Aqua  
Blue-021



Orchid  
White-022



Marigold  
Yellow-023



Raspberry  
Red-025



Fresh  
Lime-026

# Godrej interio



**AVAILABLE IN OVER 600 LOCATIONS ACROSS INDIA**  
Put some play into your work by visiting  
[godrejinterio.com](http://godrejinterio.com)

An initiative by Godrej Interio, the first Indian furniture company with **GREENGUARD** certified products

MODULAR FURNITURE • DESKING • SEATING • ACTIVE SEATING • CUE • STORAGE • SOCIAL OFFICE • COLOUR SWATCH

## Local Address

*In keeping with the Godrej policy of continuous development and improvement, the design, dimension and specification may be updated without prior notice or obligations. Form, Colour and Finish of product in this document are representative of design intent and may vary from actual. Colour options depicted in this catalogue are as close to what modern printing processes allow. All dimensions are in 'cm' and are subject to commercial tolerance. Our products are meant for indoor use only.*

## National

North: Delhi, Chandigarh, NCR, Lucknow  
South: Chennai, Bengaluru, Hyderabad, Kochi  
West: Mumbai, Ahmedabad, Bhopal, Pune  
East: Kolkata, Bhubaneswar, Guwahati, Patna

## Godrej & Boyce Mfg. Co. Ltd.

Godrej Interio, Pirojshanagar, Vikhroli (W), Mumbai – 400 079.  
Toll Free Number: 1800-267-1122. Fax: +91-22-6796 1503  
Email: [interiooffice@godrej.com](mailto:interiooffice@godrej.com)  
Website: [www.godrejinterio.com](http://www.godrejinterio.com)

## Follow us on

